

Bi-Spectral Network Camera User Manual



Issue

V 1.0

Date

2023-09-07





Precautions

Precautions

Fully understand this document before using this device, and strictly observe rules in this document when using this device. If you install this device in public places, provide the tip "You have entered the area of electronic surveillance" in an eye-catching place. Failure to correctly use electrical products may cause fire and severe injuries. To prevent accidents, carefully read the following context:

Symbols

This document may contain the following symbols whose meanings are described accordingly.

Symbol	Description
 DANGER	It alerts you to fatal dangers which, if not avoided, may cause deaths or severe injuries.
 WARNING	It alerts you to moderate dangers which, if not avoided, may cause minor or moderate injuries.
 CAUTION	It alerts you to risks. Neglect of these risks may cause device damage, data loss, device performance deterioration, or unpredictable results.
 TIP	It provides a tip that may help you resolve problems or save time.
 NOTE	It provides additional information.



DANGER

To prevent electric shocks or other dangers, keep power plugs dry and clean.



WARNING

- Strictly observe installation requirements when installing the device. The manufacturer shall not be held responsible for device damage caused by users' non-conformance to these requirements.

- Strictly conform to local electrical safety standards and use power adapters which are marked with the LPS standard when installing and using this device. Otherwise, this device may be damaged.
- Use accessories delivered with this device. The voltage must meet input voltage requirements for this device.
- If this device is installed in places with unsteady voltage, ground the device to discharge high energy such as electrical surges in order to prevent the power supply from burning out.
- When this device is in use, ensure that no water or any liquid flows into the device. If water or liquid unexpectedly flows into the device, immediately power off the device and disconnect all cables (such as power cables and network cables) from this device.
- Do not place the thermal imaging camera and unpackaged products at a radiation source with a high intensity regardless of whether the device is in the normal power-on state, for example, the sun, laser, and electric arc welder, and place the thermal imaging camera and unpackaged products against objects with a high heat source, for example, the sun. Otherwise, the accuracy of the thermal imaging camera will be affected. In addition, the detector in the thermal imaging camera may be permanently damaged.
- If this device is installed in places where thunder and lightning frequently occur, ground the device nearby to discharge high energy such as thunder strikes in order to prevent device damage.



CAUTION

- Unless otherwise specified in the user manual, do not use the thermal imaging camera in an environment with the temperature lower than -20°C (-4°F) or higher than 60°C ($+140^{\circ}\text{F}$). Otherwise, the images displayed by the thermal imaging camera are abnormal and the device may be damaged if working beyond the temperature range for a long period.
- During the outdoor installation, prevent the morning or evening sunlight incidence to the lens of the thermal imaging camera. The sun shade must be installed and adjusted according to the angle of the sunlight illumination.
- Avoid heavy loads, intensive shakes, and soaking to prevent damages during transportation and storage. The warranty does not cover any device damage that is caused during secondary packaging and transportation after the original packaging is taken apart.
- This device is a static sensitivity device. Improper static may damage the thermal imaging camera. ESD protection measures and reliable grounding must be well prepared for device installation and uninstallation.
- Protect this device from fall-down and intensive strikes, keep the device away from magnetic field interference, and do not install the device in places with shaking surfaces or under shocks.
- Use a soft and dry cloth to clean the device body. In case that the dirt is hard to remove, use a dry cloth dipped in a small amount of mild detergent and gently wipe

the device, and then dry it again. Pay special attention to the front window of the thermal imaging camera because this is precision optics. If the front window has water spots, use a clean and soft cloth moistened with water to wipe it. If the front window needs further cleaning, use a soft cloth dampened with isopropyl alcohol or detergent. Improper cleaning can cause damage to the device.

- The lens window of the thermal imaging camera is designed to be applicable to an outdoor environment. The window is coated with durable coating material, but may require frequent cleaning. When you found lens image degradation or excessive accumulation of pollutants, you should clear up the window in a timely manner. Exercise caution when you use this device in severe sandstorm (such as deserts) or corrosive environments (such as offshore). Improper use may cause surface coating off.
- Do not jam the ventilation opening. Follow the installation instructions provided in this document when installing the device.
- Keep the device away from heat sources such as radiators, electric heaters, or other heat equipment.
- Keep the device away from moist, dusty, extremely hot or cold places, or places with strong electric radiation.
- If the device is installed outdoors, take insect- and moisture-proof measures to avoid circuit board corrosion that can affect monitoring.
- Remove the power plug if the device is idle for a long time.
- Before unpacking, check whether the fragile sticker is damaged. If the fragile sticker is damaged, contact customer services or sales personnel. The manufacturer shall not be held responsible for any artificial damage of the fragile sticker.

Special Announcement

All complete products sold by the manufacturer are delivered along with nameplates, operation instructions, and accessories after strict inspection. The manufacturer shall not be held responsible for counterfeit products.

This manual may contain misprints, technology information that is not accurate enough, or product function and operation description that is slightly inconsistent with the actual product. The manufacturer will update this manual according to product function enhancement or changes and regularly update the software and hardware described in this manual. Update information will be added to new versions of this manual without prior notice.

This manual is only for reference and does not ensure that the information is totally consistent with the actual product. For consistency, see the actual product.

Contents

Precautions	I
Contents	IV
1 Product Overview	1
1.1 About Product.....	1
1.2 Device Dimension.....	1
1.3 Installation.....	4
1.1.1 Installation Mode	4
1.1.2 Installing Bracket Without Junction Box.....	4
1.1.3 Installing Bracket With Junction Box.....	5
1.4 Cable Connection	7
2 Quick Configuration	10
2.1 Login and Logout	10
2.2 Homepage Layout	11
2.3 Changing the Password	13
2.4 Browse Video	14
2.5 People Counting	17
2.6 Setting Local Network Parameters	18
3 Configuring Thermal	22
3.1 Temperature Parameters	22
3.2 Ambient Temperature	27
3.3 Temperature Area	27
3.4 Privacy Zone Masking.....	33
3.5 Schedule Linkage	34
3.6 Thermal Mapping	41
3.7 Defect Pixel Correction.....	43
3.8 LED Control Param.....	44
4 Visible Image Settings	46
4.1 Accessing Image Settings Interface.....	46
4.2 Mode	47

4.3 Image.....	47
4.4 Scene	49
4.5 Exposure.....	49
4.6 WB	51
4.7 DayNight.....	52
4.8 Noise Reduction.....	54
4.9 Enhance Image.....	55
5 Thermal Image Settings.....	57
5.1 Accessing the Image Settings Interface	57
5.2 Mode	58
5.3 Images	58
5.4 Scene	59
5.5 Set Pseudocolor.....	60
5.6 FFC Control	61
5.7 Noise Reduction.....	63
6 Intelligent Analysis.....	65
6.1 Intrusion	65
6.2 Single Line Crossing	69
6.3 Double Line Crossing.....	71
6.4 People Counting.....	74
7 Advanced Intelligent Analysis.....	79
7.1 Smoker Detection.....	79
7.2 Smoke and Flame Detection.....	82
7.3 Fire Spot Detection.....	85
8 AI Multi-object.....	89
9 Alarm Setting.....	91
9.1 Alarm Output.....	91
9.2 Disk Alarm	92
9.3 Network Alarm.....	92
9.4 I/O Alarm Linkage	93
9.5 Motion Alarm.....	94
9.6 Push Message.....	95
9.7 Audio Abnormal Output.....	96
10 Other Web Configurations.....	98
10.1 Device Information	98

10.2 Stream	99
10.2.1 Base Stream.....	99
10.2.2 ROI.....	100
10.2.3 Snapshot.....	101
10.3 Device	102
10.4 External Device	102
10.5 Privacy Masking.....	104
10.6 Network Service.....	104
10.6.1 QOS	104
10.7 Privacy Manager	105
10.8 Protocol	106
10.9 Device Log	107
10.10 Maintenance	107
10.11 Local Config.....	108
11 A Troubleshooting.....	109

1 Product Overview

1.1 About Product

- The Bi-spectrum network camera is integrated with the thermal imaging and temperature measuring, visible fusion, core image intelligent analysis, etc.
- Unique double registration mechanism, visible light and thermal imaging is reflecting the same scene.
- The Bi-spectrum network camera is high precision, built-in automatic temperature correction, completely eliminate the temperature drift, it can work stable and reliable for long time.
- Intelligent temperature and visible light image channel display details information to easily monitor and discriminate.
- Smart over temperature alarm and location, sound and light alarm, track rapidly when temperature was abnormal.

It can be widely used in important fields such as airports, stations, urban roads, traffic surveys, corporate security, warehouse monitoring, and residential security.

1.2 Device Dimension

Figure 1-1 shows the dimensions of device.

Figure 1-1 Dimensions (unit: mm)

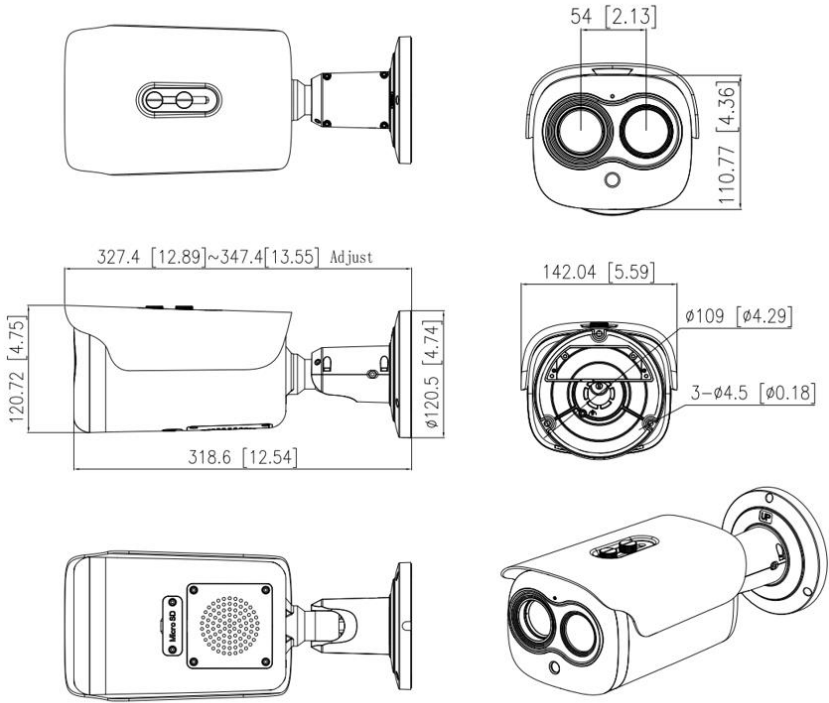

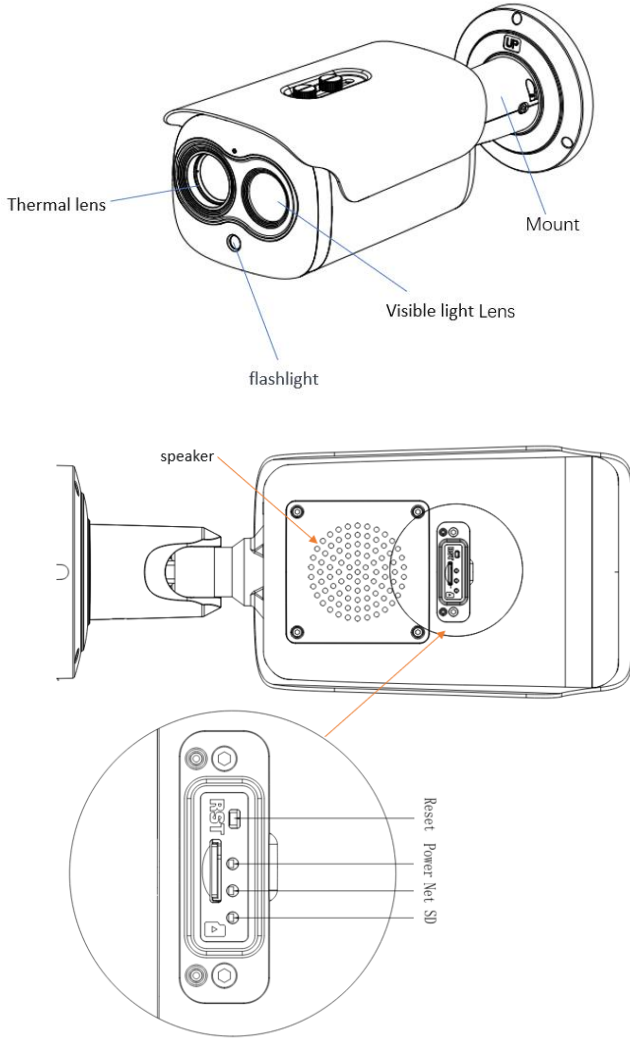

Reset : Reset button, long press for 5s to restore to factory settings.

Power : If the power is normal, the red light is on.

NET: Network indicator, if the data is transiting, the green light is flash.

SD: SD card indicator, if the card is plugged, the blue light is on.

1.3 Installation

1.1.1 Installation Mode

The thermal imaging bullet camera can be installed on the ceiling or the wall. You can select the appropriate installation according to your requirements. If the camera needs to be installed on the cement wall, you need to install the expansion screws (the mounting holes of the screws must be consistent with that of the support), and then install the support.

NOTE

The wall where the bracket is mounted must be able to withstand at least three times of the total weight of the bracket and the camera.

The different brackets have different installation methods, please choose the correspond method according to the purchased product.

1.1.2 Installing Bracket Without Junction Box

Step 1 Take out the installation location label from the package, stick it on the ceiling or the wall.

Step 2 According to the location hole positions shown in the installation location label, punch three location holes on the ceiling or the wall.

Step 3 Drive the plastic anchors into the holes, as shown in Figure 1-2.

Figure 1-2 Installation Location Label

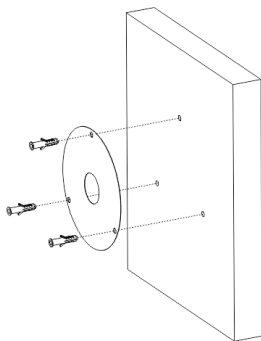

Step 4 Align the holes in bracket with the plastic anchors in ceiling or wall, fix the bracket with self-tapping screws, as shown in Figure 1-3.

Figure 1-3 Fixing Camera

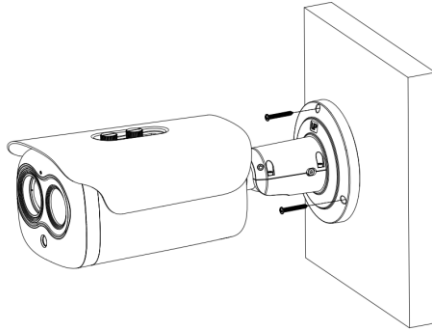

Step 5 Connect the multi connector cable. Loosen the screw 1 and screw 2, adjust the surveillance angle

Step 6 After adjusting angle, fix screw 2 and screw 1 in turn to finish installation, as shown in Figure 1-4.

Figure 1-4 Adjust the Surveillance Angle

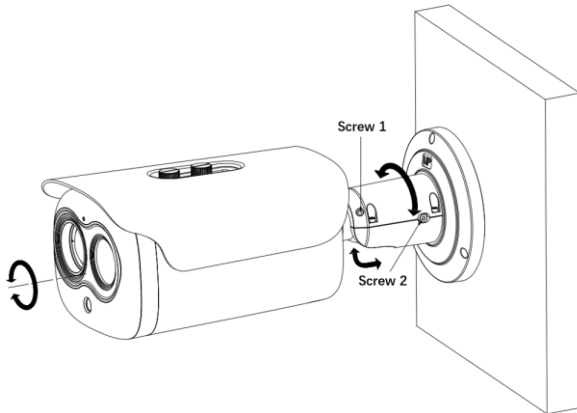

----End

1.1.3 Installing Bracket With Junction Box

Step 1 Take out the installation location label from the package, stick it on the ceiling or the wall. According to the location hole positions shown in the installation location label, punch four location holes on the ceiling or the wall.

Step 2 Drive the plastic anchors into the holes, fix the junction box by self-tapping screws, as shown in Figure 1-5.

Figure 1-5 Fixing Junction Box

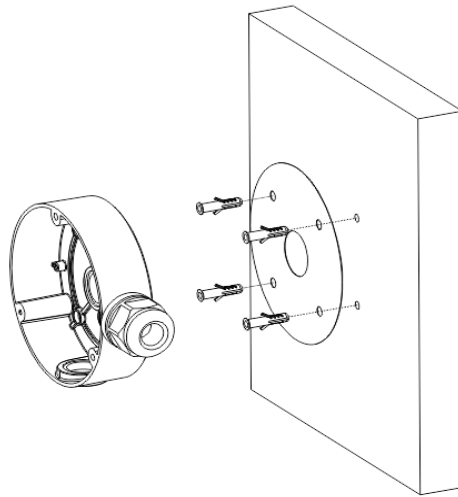

Step 3 Wiring of junction box. Align the holes in bracket with the box and fix the camera to the box with self-tapping screws, as shown in Figure 1-6.

Figure 1-6 Fix the Camera to Junction Box

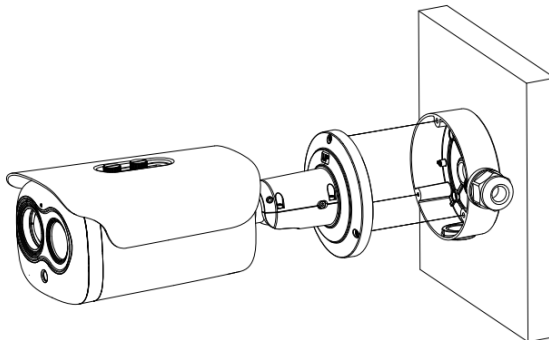

Step 4 Connect the multi connector cable. Loosen screw 1 and screw 2, adjust the surveillance angle, as shown in Table 7-2.

Figure 1-7 Adjust the Surveillance Angle

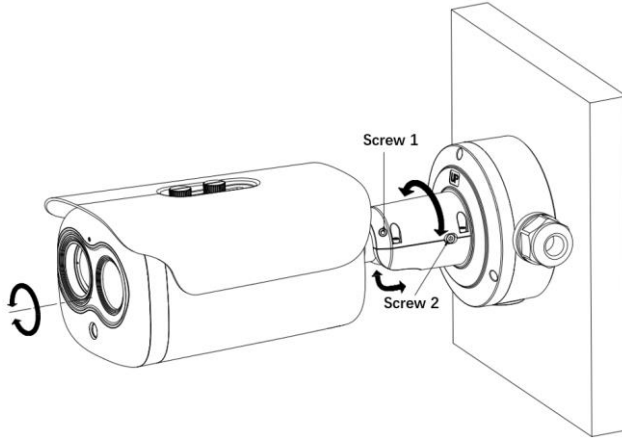

Step 5 After adjusting angle, fix screw 2 and screw 1 in turn to finish installation.

 **NOTE**

There are three pipe thread interface in the junction box, one of which needs to be used with Grand head, so our company provides two plugs.

Figure 1-8 Installing Plug

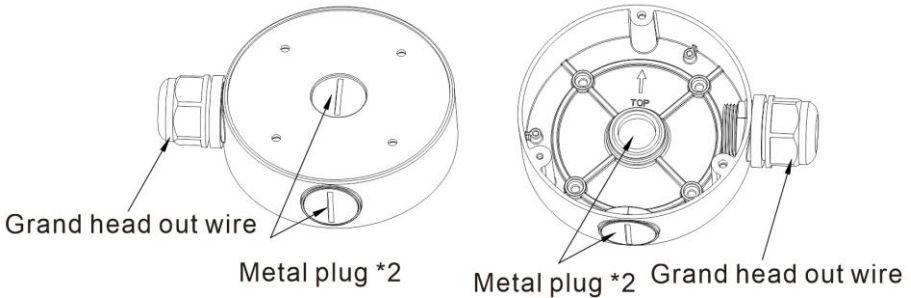

---End

1.4 Cable Connection

Figure 1-9 shows the ports of multi-pole combined cables. Table 1-1 describes the ports.

 **NOTE**

The different models may have different cables, please refer to actual product.

Figure 1-9 Multi-connector combination cables

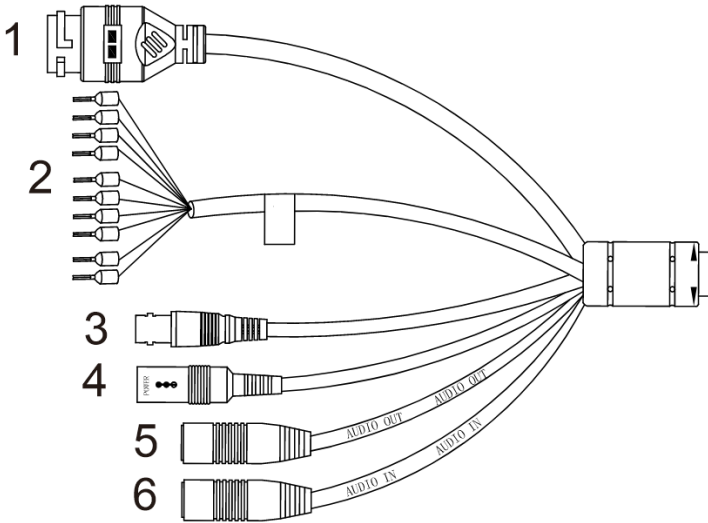

Table 1-1 Multi-connector combination cables

ID	Core of Cable	Functions
1	Network interface	Connect to the standard Ethernet cable. Support PoE power supply.
2	ALARM1	Alarm in/ alarm out 1 Brown: alarm OUT COM 1 Blue: alarm OUT 1 White: alarm IN COM 1 Green: alarm IN 1
	ALARM 2	Alarm in/ alarm out 2 Orange: alarm OUT COM 2 Yellow: alarm OUT 2 Grey: alarm IN COM 2 Purple : alarm IN 2
	RS485	RS485 interface connects to the external pan & tilt. Pink & red is RS485+ Black & white is RS485-

3	BNC	CVBS interface
4	DC12V/AC24V (2A)	Power interface, connects to the DC12V or AC24V (2A)
5	Audio Output	Connect to the external audio device such as the voice box.
6	Audio Input	Input the audio signal and receives the analog audio signals from the sound pick-up device.

2 Quick Configuration

2.1 Login and Logout



CAUTION

To access the web interface through Microsoft Edge, Chrome or Firefox browser; This document uses Firefox browser as an explanation. If there are some differences between different browsers, please refer to actual product!

Login system

Step 1 Open the Microsoft Edge, enter the IP address of IP camera (default value: 192.168.0.121) in the address box, and press Enter.

The login page is displayed, as shown in Figure 2-1.

Figure 2-1 Login page

IP CAMERA

English ▾

User Name

Password

Step 2 Input the User and password.

 **NOTE**

- The default name and password both are **admin**. Modify the password when you log in the system for first time to ensure system security. After modifying password, you need to wait at least three minutes then power off to make sure modifying successfully . Or login the Web again to check the new password.
- User can change the system display language on the login page.

Step 3 Click Login arrow to enter main interface.

Logout

Click  in the top right to back to Web Login.

----End

2.2 Homepage Layout











On the homepage, user can view Live Video, playback, people counting and configuration. User can set image settings, video parameter, video control, and logout of the system. Figure 2-2 is shown the homepage layout. Table 2-1 lists the elements on the homepage layout.



Figure 2-2 Homepage layout



Table 2-1 Elements on the homepage

NO.	Element	Description
1	Live Video	View the Live Videos for both channels.
2	Playback	You can query the playback videos in this area if you plug in SD card and open the recording.

NO.	Element	Description
3	People Counting	Set the query condition to query the personnel count, the statistical can be shown in different types, such as line chart, histogram, list, the detail information please refer to chapter 2.4
4	Configuration	You can choose a menu to set device parameters, including the device information, image settings, audio and video streams, thermal parameter, AI functions, alarm setting, privacy mask function.
5		Download the latest plugin IPC Local Server, you can choose the plugin to play H.265 video smoothly.
6		Status of download recording.
7	Change Password	You can click  to change the password.
8	Sign Out	You can click  to return to the login page.
9	Switch to No Plugin Play	When users download the IPC Local Server, you can switch to plugin or no-plugin play live video.
10	Stream	The visible light channel has two streams. You can set details at configuration base stream interface. The thermal image channel has two streams
11	-	 : Play/pause  : Audio  : Interphone  : Snapshot; The plugin play mode, the file will be saved to the Local Config path. The no-plugin play mode, the file will be saved to the default download path of browser.  : Record video to local storage.  : Click the icon to switch to AI live video, you can view the snapshots of AI multi object, there are face, plate, car, human body, riding.

When the device generates an alarm, the alarm icon  is displayed. You can click  to view the alarm information.



NOTE

When the device accepts an alarm signal, the alarm icon will display within 10s in the web management system.



: When users don't download the IPC local server, the help icon will be shown. Click the icon to show detail information.

Figure 2-3 About the Intercom Function

About the intercom function: ✕

Description: Only for enabling the Two-way Audio (Camera) in Chrome on HTTP in Chrome for (local) insecure origins. On HTTPS, all browsers are compatible with Two-way Audio (Camera).
HTTP Environment Chrome Opens the intercom step:

- 1.Navigate to 'chrome://flags/#unsafely-treat-insecure-origin-as-secure' in Chrome.
- 2.Find and enable the 'Insecure origins treated as secure'
- 3.Add any camera addresses you want to ignore the secure origin policy for on the input box. The comma (',') is used to separate multiple camera addresses. For Example
http://192.168.0.123, http://192.168.0.123:8045
- 4.Left-click outside the input box to save it and relaunch Chrome.

----End

2.3 Changing the Password

Description

User can click  to change the password for logging into the system.

Procedure

Step 1 Click  in the upper right corner of the main page.

The **Change Password** dialog box is displayed, as shown in Figure 2-4.

Figure 2-4 Change password dialog box

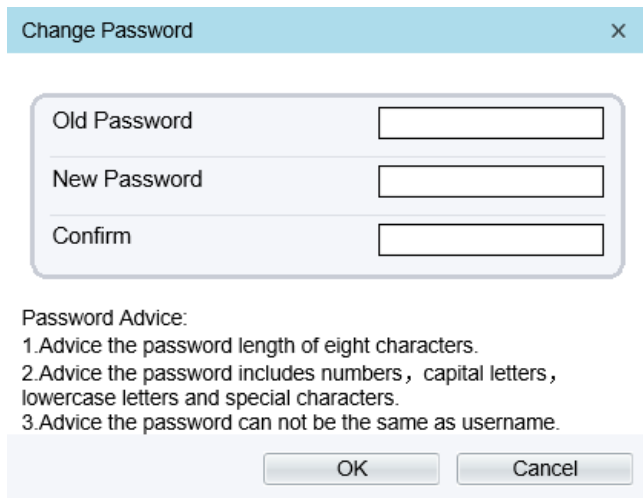

Change Password

Old Password

New Password

Confirm

Password Advice:

1. Advice the password length of eight characters.
2. Advice the password includes numbers, capital letters, lowercase letters and special characters.
3. Advice the password can not be the same as username.

OK Cancel

**NOTE**

- The change password page will be displayed if you don't change the default password when you login the system for the first time.

Step 2 Input the old password, new password, and confirm password.

Step 3 Click **OK**.

If the message "**Change password success**" is displayed, the password is successfully changed. If the password fails to be changed, the cause is displayed. (For example, the new password length couldn't be less than eight.)

----End

2.4 Browse Video

Procedure

If you want to play H.265 type video smoothly, you should download the latest IPC Local Server, as shown in Figure 2-5, when you login to the web management system for the first time.

Figure 2-5 The Plugin download Page



Step 1 Click “ Please download the latest plugin”, download the IPC Local Server plugin.

Step 2 Open the download file, double-click to install the file.

Step 3 Click “Run”, select destination location as shown in Figure 2-6.

Figure 2-6 Select Destination Location

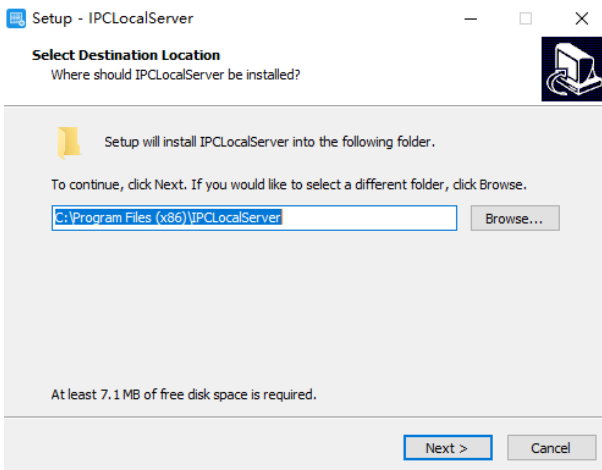

Step 4 Click “Next”, ready to install the plugin, as shown in Figure 9-7.

Figure 2-7 Select Additional Tasks

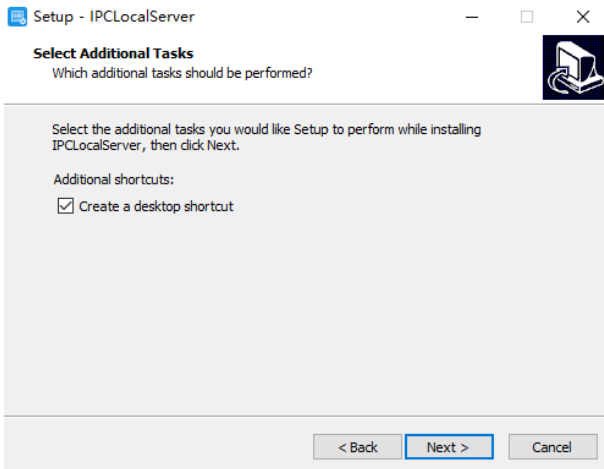

Step 5 Tick “Create a desktop shortcut”, Click “Next” to install the plugin, as shown in Figure 2-8.

Figure 2-8 Installing

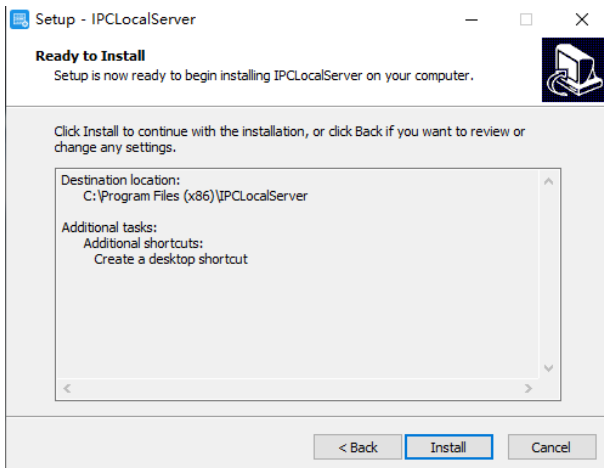

Step 6 Click “Finish”, complete complete plugin installation, as shown in Figure 2-9.

Figure 2-9 Complete to Install the Plugin

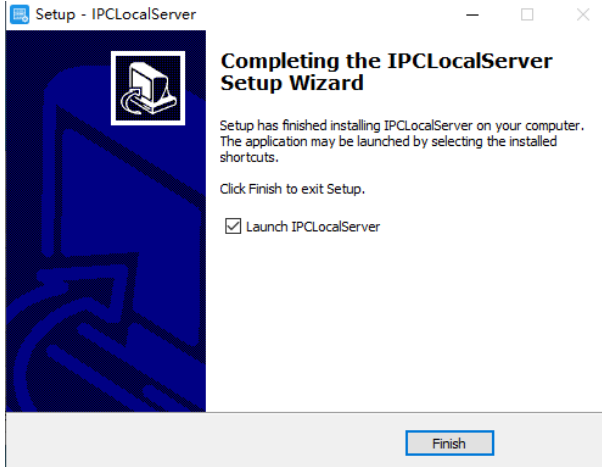

Step 7 Reopen the browser after installing.

 **NOTE**

- If the repair tips displayed when installing the control, please ignore the prompt, and continue the installation.
- During installing the plugin, the browser should be closed.

----End

2.5 People Counting

At **People Counting** interface, you can view the personnel count throughout setting query condition (choose the detail time at date's popup up window).

There are three modes to show the data, such as line chart, histogram, and list, as shown in Figure 2-10.

Figure 2-10 People Counting Interface



Click “Download” to download the query result.

Choose the mode of showing result, such as line chart, histogram, list.

Click “Query” to query the data of people counting.

User can download the result to local folder.

2.6 Setting Local Network Parameters

Description

Local network parameters include:

- IP protocol
- IP address
- Subnet mask
- Default gateway
- Dynamic Host Configuration Protocol (DHCP)
- Preferred Domain Name System (DNS) server
- Alternate DNS server
- MTU

Procedure

Step 1 Choose **Configuration > Device > Local Network**.

The **Local Network** page is displayed, as shown in Figure 2-11.

Figure 2-11 Local network

Local Network

Network Card ID: 1

IP Protocol: IPv4

DHCP: OFF

IP Address: 192.168.0.121

Subnet Mask: 255.255.255.0

Default Gateway: 192.168.0.1

Preferred DNS Server: 192.168.0.1

Alternate DNS Server: 192.168.0.2

MTU(1280-1500): 1500

Refresh Apply

Step 2 Set the parameters according to Table 2-2.

Table 2-2 Local network parameters

Parameter	Description	Setting
IP Protocol	IPv4 is the IP protocol that uses an address length of 32 bits.	[Setting method] Select a value from the drop-down list box. [Default value] IPv4

Parameter	Description	Setting
DHCP	The device automatically obtains the IP address from the DHCP server.	[Setting method] Click the option button. NOTE To query the current IP address of the device, you must query it on the platform based on the device name.
DHCP IP	IP address that the DHCP server assigned to the device.	N/A
IP Address	Device IP address that can be set as required.	[Setting method] Enter a value manually. [Default value] 192.168.0.121
Subnet Mask	Subnet mask of the network adapter.	[Setting method] Enter a value manually. [Default value] 255.255.255.0
Default Gateway	This parameter must be set if the client accesses the device through a gateway.	[Setting method] Enter a value manually. [Default value] 192.168.0.1
Preferred DNS Server	IP address of a DNS server.	[Setting method] Enter a value manually. [Default value] 192.168.0.1
Alternate DNS Server	IP address of a domain server. If the preferred DNS server is faulty, the device uses the alternate DNS server to resolve domain names.	[Setting method] Enter a value manually. [Default value] 192.168.0.2

Parameter	Description	Setting
MTU	Set the maximum value of network transmission data packets.	[Setting method] Enter a value manually. NOTE The MTU value is range from 1280 to 1500, the default value is 1500, Please do not change it arbitrarily.

Step 3 Click **OK**.

- If the message "**Apply success**" is displayed, click OK. The system saves the settings. The message "**Set network param's success**, please login system again" is displayed. Use the new IP address to log in to the web management system.
- If the message "Invalid IP Address", "**Invalid Subnet Mask**", "**Invalid default gateway**", "**Invalid primary DNS**", or "**Invalid space DNS**" is displayed, set the parameters correctly.



NOTE

- If you set only the Subnet Mask, Default Gateway, Preferred DNS Server, and Alternate DNS Server parameters, you do not need to login to the system again.
- You can click Reset to restore the previous parameters if required.

----**End**

3 Configuring Thermal

3.1 Temperature Parameters

Temperature parameters include temperature unit, ambient type, ambient temperature, cavity temperature, correctional coefficient, area temperature display mode, area temperature type, measure mode, area alarm interval and so on.

Operation Procedure

Step 1 Choose **Configuration > Thermal > Temperature Parameters**.

The **Temperature Parameters** page is displayed, as shown in Figure 3-1.

Figure 3-1 Temperature Parameters Interface

 **Temperature Parameters**

Temperature Measurements	<input type="checkbox"/> ON
Temperature Units	Celsius
Length Units	Meters
Cavity Temperature	35.73
Correction Coefficient	0.00
Area ID Display Mode	Area ID
Area Temperature Display Mode	Low Left
Font Border	<input type="checkbox"/> ON
Font Size	Mid
Area Temperature Type	Highest Temperature
Measure Mode	General
Display Alarm Area	<input type="checkbox"/> OFF
Area Alarm Interval (1-1800s)	10
Area Alarm Delay (0-10s)	0
Temperature Range	-20.0 ~ 150.0
Prevent Overheating	Auto
Duration (5-60s)	60

Step 2 Set the parameters according to Table 3-1.

Table 3-1 Temperature Parameters

Parameter	Description	Setting
Temperature Unit	Celsius and Fahrenheit temperature units are available.	[Setting method] Select a value from the drop-down list box. [Default value] Celsius
Length units	Meters and feet length units are available.	[Setting method] Select a value from the drop-down list box. [Default value] Meters
Cavity Temperature	The cavity temperature of camera.	N/A
Correction Coefficient	Correction coefficient is refer to the deviation of measured object temperature and actual temperature, is offset value. For example: 1. The measured object temperature is 20, and actual temperature is 20.5, so the correction coefficient should be 0.5 . 2. The measured object temperature is 20, and actual temperature is 19.5, so the correction coefficient should be -0.5. NOTE User should contact the technical support staff of our company at this condition to make sure to apply	[Setting method] Enter a value manually. [Default value] 0.00
Area ID display mode	There two mode to display, area ID and area name	[Setting method] Select a value from the drop-down list box. [Default value] Area ID

Parameter	Description	Setting
Area Temperature Display Mode	The display position of temperature information on the live-video image.	[Setting method] Select a value from the drop-down list box. [Default value] Low left
Font Border	Enable to bold the font	[Setting method] Enable or disable [Default value] Disable
Font size	There are three font sizes that can be chosen, small/mid/big	[Setting method] Enable or disable [Default value] Mid
Area Temperature Type	There are three types of area temperature.	[Setting method] Select a value from the drop-down list box. [Default value] Highest Temperature
Measure Mode	There are two types of measure modes.	[Setting method] Select a value from the drop-down list box. [Default value] General
Display Alarm Area	N/A	[Setting method] Enable or disable [Default value] Disable
Area Alarm Interval (1-1800s)	N/A	[Setting method] Enter a value manually ranges from 1 to 1800. [Default value] 10
Area Alarm delay (0-10S)	N/A	[Setting method] Enter a value manually ranges from 1 to 10. [Default value] 10

Parameter	Description	Setting
Temperature range	It depends on the device. Different devices have different modes, there are two ranges, such as -20 °C -150°C, -40 °C-150°C. The thermal imaging box network camera is -40 °C-150°C.	[Setting method] Select a value from the drop-down list box.
Prevent Overheating	Open, if temperature of the testing area is too high, you can enable it to prevent over heat function. The control cover will be lay down to keep the detector safe. There are two types, manual and auto.	[Setting method] Select a value from the drop-down list box.
Duration(5-60 S)	Prevent over heat' mode is auto, the control cover will block for duration time automatically if over heat.	[Setting method] Enter a value manually ranges from 5 to 60.

Figure 3-2 Advanced Interface



Table 3-2 Advance Parameters

Parameter	Description	Setting
Dimming Mode	There are auto and manual modes. Auto: It will show on temperature item depend on the full screen temperature. Manual: it will show on the manual value.	[Setting method] Select a value from the drop-down list box. [Default value] Auto
Greater Prominent	Enable that, the image will show the setting color if the temperature is higher than set value.	[Setting method] Enter a value manually. Choose one color to show.
Section Prominent	Enable that, the image will show the setting color if the temperature is between minimum and maximum temperature.	[Setting method] Enter a value manually. Choose one color to show.
Less Prominent	Enable that, the image will show the setting color if the temperature is lower than set value.	[Setting method] Enter a value manually. Choose one color to show.
Raw Data Upload Interval(F/S)	Interval of uploading the raw data.	[Setting method] Select a value from the drop-down list box. [Default value] 1
Mix Stream Mode	This function is used for mixing thermal and visible imaging, if you want to adjust the location, please set at thermal channel “ Configuration > Image Settings > Set Pseudocolor” tab interface. There are close, mode 1 mode 2, and mode 3. The different models maybe have different displays; Please refer to the actual product.	[Default value] Close

----End

3.2 Ambient Temperature

Figure 3-3 Ambient Temperature

Ambient Temperature

Ambient Temperature	<input type="text" value="25.00"/>	°C
Cavity Temperature	<input type="text" value="20.62"/>	°C

Refresh

Apply

Table 3-3 Parameter of Ambient Temperature

Parameter	Description	Setting
Ambient Temperature	Environment temperature of camera.	[Setting method] Enter the temperature of ambient environment. [Default value] 25
Cavity Temperature	Set the ambient temperature, click “Apply”, click “Refresh” ,the camera will get the value automatically.	---

----End

3.3 Temperature Area

Operation Procedure

Step 1 Choose **Configuration > Thermal > Temperature Area**.

The **Temperature Area** page is displayed, as shown in Figure 3-4.

Figure 3-4 Temperature Area and Alarm Configuration

Alarm Configuration

Channel: 1
Measure Mode: General

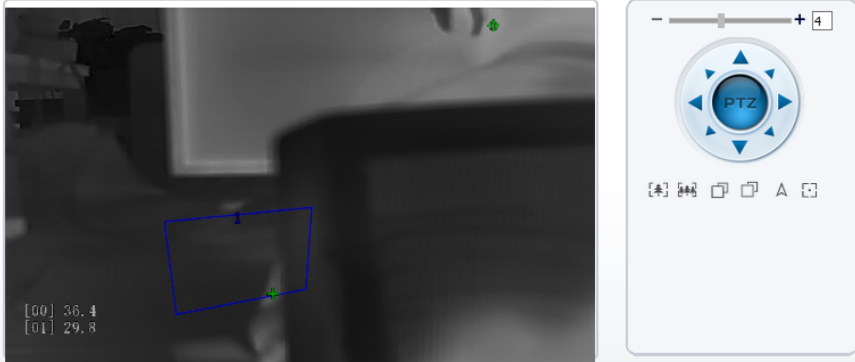

Clear

Enable	ID	Name	Type	Alarm Type	Warning Value	Alarm Value	Maximum Alarm	Duration(1-)
<input checked="" type="checkbox"/>	0	Area0	Rectangle	Threshold Alarm	48.00	50.00	60.00	1.00
<input checked="" type="checkbox"/>	1	Area1	Polygon	Threshold Alarm	48.00	50.00	60.00	1.00
<input type="checkbox"/>	2	Area2	Point	Threshold Alarm	48.00	50.00	60.00	1.00
<input type="checkbox"/>	3	Area3	Point	Threshold Alarm	48.00	50.00	60.00	1.00
<input type="checkbox"/>	4	Area4	Point	Threshold Alarm	48.00	50.00	60.00	1.00
<input type="checkbox"/>	5	Area5	Point	Threshold Alarm	48.00	50.00	60.00	1.00
<input type="checkbox"/>	6	Area6	Point	Threshold Alarm	48.00	50.00	60.00	1.00
<input type="checkbox"/>	7	Area7	Point	Threshold Alarm	48.00	50.00	60.00	1.00

Refresh Apply

Step 2 Set the parameters according to Table 3-4.

Table 3-4 Temperature Area and Alarm Configuration

Parameter	Description	Setting
Channel	Channel 1 is visible channel. Channel 2 is thermal channel.	[Setting method] Select a value from the drop-down list box. [Default value] 2

Parameter	Description	Setting
Measure Mode	Set at temperature parameter interface.	N/A
Enable	Tick the ID to enable the area measuring.	[Setting method] Tick
Name	Area name of temperature area.	[Setting method] Enter a value manually.
Type	Type of temperature area. ID 0 is default rectangle area, which is full screen.	[Setting method] Select a value from the drop-down list box. [Default value] Rectangle/Point
Alarm Type	Threshold alarm, temperature difference alarm, section alarm, temperature rise alarm are available for the alarm type. Section Alarm: if the temperature value is among the set temperature range, it will generate the alarm. Temperature rise alarm means if the rising temperature value is more than the set value, it will generate the alarm.	[Setting method] Select a value from the drop-down list box. [Default value] Threshold alarm
Warning Value	Camera will trigger warning alarm when the object temperature reaches the warning value.	[Setting method] Enter a value manually. [Default value] 48
Alarm Value	Camera will alarm when the object temperature reaches the alarm value.	[Setting method] Enter a value manually. [Default value] 50
Maximum Alarm Value	At section alarm type, the device would not alarm when the temperature is higher than maximum alarm value.	[Setting method] Enter a value manually. [Default value] 60.00
Duration (1-10S)	Choose temperature rise alarm, set the duration. the temperature value rises within duration setting, the alarm is triggered successfully.	[Setting method] Enter a value manually. [Default value] 1.00

Parameter	Description	Setting
Emission Rate	The emission rate is the capability of an object to emit or absorb energy. The emission rate should be set only when the target is special material.	[Setting method] Enter a value manually. [Default value] 0.95
Distance(M)	The distance between camera and target.	[Setting method] Enter a value manually. [Default value] 15  NOTE Enter actual distance when the distance between camera and target is less than 15m. Enter 15 when the distance between camera and target is great than or equal to 15m.
Reflect Enable	When there are some high temperature objects on scene, and the temperature reflect to the other object, you can enable this function to calibrate the temperature.	[Setting method] Tick to enable
Reflect Temperature	The temperature of high temperature object.	[Setting method] Enter a value manually. [Default value] 50.00
Ignore Object	Enable to shield the temperature of area capturing AI object.	[Setting method] Select a value from the drop-down list box.
Alarm	Enable or disable the alarm output and linkage of area.	[Setting method] Tick to enable alarm.
Masking	Enable, the device will shield this area's temperature.	[Setting method] Tick to shield.

Parameter	Description	Setting
Group ID	<p>The ID can be chosen into one of six groups, or no group. The group will be alarm following as the next rules:</p> <p>A=The highest temperature of groups (the highest temperature of N regions is the largest)</p> <p>B=Average temperature of groups (average temperature of N regions)</p> <p>WA=Warning value</p> <p>AA=Alarm value</p> <p>a. If $A-B \geq WA$, a temperature difference warning signal is generated ---> (the one with the largest difference between the N areas and the average temperature is the alarm area flashing)</p> <p>b. If $A-B \geq AA$, a temperature difference alarm signal is generated ---> (the one with the largest difference between the N areas and the average temperature is the alarm area flashing)</p> <p>c. If the warning and alarm conditions are met at the same time, the alarm signal will be generated first.</p>	<p>[Setting method]</p> <p>Select a value from the drop-down list box.</p>

Step 3 Set temperature area.

1. Tick an area ID.
2. Press and hold the left mouse button, and drag in the video area to draw a temperature area, as shown in Figure 3-5. Right-click to finish the area selected.

Figure 3-5 Temperature Area Setting Interface

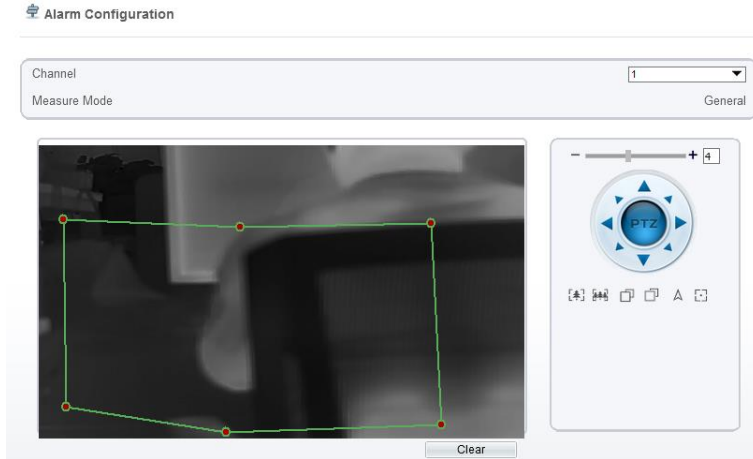

3. Click **Apply**, the message “Apply success” is displayed, the temperature area is set successfully.

**NOTE**

ID 0 is the full screen; The area cannot be changed.



: the lowest temperature of the full screen.



:the highest temperature of the full screen.



: the lowest temperature of the area.



: the highest temperature of the area.

Delete a temperature area:

1. Select an area ID.
2. Click **Clear**.
3. Remove the tick of area ID.
4. Click **Apply**, the message “Apply success” is displayed, the temperature area is deleted successfully.

Step 4 Click Apply.

The message "Apply success" is displayed, the system saves the settings.

----End

3.4 Privacy Zone Masking

Privacy zone masking is meaning that the camera will do not detect the temperature of that area. The shield areas can be set up to eight areas.

Operation Procedure

Step 1 Choose **Configuration > Thermal > Privacy Zone Masking**.

Figure 3-6 Privacy Zone Masking

Privacy Zone Masking



Step 2 Enable the shield area.

Step 3 Enable Show Privacy Zone Masking, then the setting shield will show on live video.

Step 4 Click-left mouse button to set area; Click-right mouse button to end the setting.

Step 5 Click **Clear** to clear the shield area.

----End

3.5 Schedule Linkage

Operation Procedure

Step 1 Choose **Configuration > Thermal > Schedule Linkage**.

The **Schedule Linkage** page is displayed, as shown in Figure 3-7.

Figure 3-7 Schedule Linkage

 **Schedule Linkage**

Threshold Alarm Threshold Warning Temperature Different Temperature Different Temperature Section /
Temperature Rise Alarm Temperature Rise Warning

Output Channel 1

Alarm Record OFF

SMTP OFF

FTP Upload OFF

Audible Alarm OFF

Flashlight Alarm OFF

Armed UnArmed

	0	1	2	3	4	5	6	7	8	9	10	11	12	13	14	15	16	17	18	19	20	21	22	23	24
Sun																									
Mon																									
Tue																									
Wed																									
Thur																									
Fri																									
Sat																									

Refresh Apply

Step 2 Tick the output channel.

Step 3 Enable wanted linkage: “Alarm Record”, “SMTP”, “FTP upload”, audible alarm, flashlight alarm.

Step 4 Set schedule linkage.

Step 5 The message "Apply success" is displayed, the system saves the settings.



● **Alarm output:** Users should connect the external alarm device (such as siren) to alarm output cables. The parameter can be set at “ Configuration > Alarm > Alarm Output” interface, as shown in Figure 3-8.

Figure 3-8 Alarm output

Table 3-5 Alarm output

Parameter	Description	Setting
Alarm Output	ID of the alarm output channel. NOTE The number of alarm output channels depends on the device model.	[Setting method] Select a value from the drop-down list box. [Default value] 1
Name	Alarm output channel name.	[Value range] 0 to 32 bytes
Valid Signal	The options are as follows: Close: An alarm is generated when an external alarm signal is received. Open: An alarm is generated when no external alarm signal is received.	[Setting method] Select a value from the drop-down list box. [Default value] Close

Parameter	Description	Setting
Alarm Output Mode	<p>When the device receives I/O alarm signals, the device sends the alarm information to an external alarm device in the mode specified by this parameter. The options include the switch mode and pulse mode.</p> <p>NOTE</p> <ul style="list-style-type: none"> • If the switch mode is used, the alarm frequency of the device must be the same as that of the external alarm device. • If the pulse mode is used, the alarm frequency of the external alarm device can be configured. 	<p>[Setting method] Select a value from the drop-down list box. [Default value] Switch Mode</p>
Alarm Time (ms) (0: Continuous)	Alarm output duration. The value 0 indicates that the alarm remains valid.	<p>[Setting method] Enter a value manually. [Default value] 0 [Value range] 0 to 86400 seconds</p>
Timing Alarm Output	Enable timing alarm output, set the schedule to time alarm.	<p>[Setting method] Enable [Default value] OFF</p>
Manual Control	Control the alarm output.	N/A

- **Alarm Record:** Users insert the SD card in camera. The recording time is set at “ **Configuration > Device Record > Record Policy**” interface.
- **SMTP:** At “ **Configuration > Network > SMTP**” interface, users should set the parameters of SMTP in advance, as shown in Figure 3-9.

Figure 3-9 SMTP

The screenshot shows the SMTP configuration page. At the top left, there is a signal icon and the text 'SMTP'. Below this is a form with the following fields and controls:

- SMTP Server Address: Text input field with a red asterisk.
- SMTP Server Port: Text input field with a red asterisk, containing the value '25'.
- User Name: Text input field with a red asterisk.
- Password: Text input field with a red asterisk.
- Send anonymously: A checkbox that is currently unchecked.
- Sender E-mail Address: Text input field with a red asterisk.
- Recipient_E-mail_Address1: Text input field with a red asterisk.
- Recipient_E-mail_Address2: Text input field.
- Recipient_E-mail_Address3: Text input field.
- Recipient_E-mail_Address4: Text input field.
- Recipient_E-mail_Address5: Text input field.
- Transport Mode: A dropdown menu currently set to 'No Encrypt'.
- Send Interval(0-60S): Text input field containing the value '0'.

At the bottom right of the form is an 'Email Test' button. Below the form are two buttons: 'Refresh' and 'Apply'.

Table 3-6 SMTP parameters

Parameter	Description	Setting
SMTP Server Address	IP address of the SMTP server.	[Setting method] Enter a value manually.
SMTP Server Port	Port number of the SMTP server.	[Setting method] Enter a value manually. [Default value] 25
User Name	User name of the mailbox for sending emails.	[Setting method] Enter a value manually.
Password	Password of the mailbox for sending emails.	[Setting method] Enter a value manually.
Sender E-mail Address	Mailbox for sending emails.	[Setting method] Enter a value manually.

Parameter	Description	Setting
Recipient_ E-mail_Address 1	(Mandatory) Email address of recipient 1.	[Setting method] Enter a value manually.
Recipient_ E-mail_Address 2	(Optional) Email address of recipient 2.	
Recipient_ E-mail_Address3	(Optional) Email address of recipient 3.	
Recipient_ E-mail_Address 4	(Optional) Email address of recipient 4.	
Recipient_ E-mail_Address 5	(Optional) Email address of recipient 5.	
Attachment Image Quality	A higher-quality image means more storage space. Set this parameter based on the site requirement.	N/A
Transport Mode	Email encryption mode. Set this parameter based on the encryption modes supported by the SMTP server.	[Setting method] Select a value from the drop-down list box. [Default value] No Encrypted

● **FTP Upload:** At “ **Configuration > Network > FTP Upload**” interface, users should set the parameters of FTP upload in advance, as shown in Figure 3-10.

Figure 3-10 FTP upload





























Table 3-7 FTP upload parameters

Parameter	Description	Setting
FTP Upload	Indicates whether to enable the FTP service.	[Setting method] Click the button on. [Default value] OFF
FTP Address	IP address of FTP server.	[Setting method] Enter a value annually.
FTP Port	Port of FTP server.	[Setting method] N/A [Default value] 21
Account	FTP server account.	[Setting method] Enter a value annually.
Password	FTP server Password.	[Setting method] Enter a value annually.
FTP Path	FTP Path to save the JPG image.	[Setting method] Enter a value annually.
Media type	The media type of sending to FTP, snapshot or video clip.	[Setting method] Select a value from the drop-down list box. [Default value] Snapshot

- **Audio Detect Alarm:** At “ **Configuration > Alarm > Audible Alarm Output**” interface, users should set the parameters of audible Alarm output in advance, as shown in Figure 3-11.

Figure 3-11 Audible alarm output

 **Audible Alarm Output**

ID	FileName	Cycle Number	Listen Test	Operate
0	high_temperature_alarm.wav	1		
1	normal_temperature.wav	1		
2	low_temperature_alarm.wav	1		
3	hello_welcome.wav	1		
4	verification_success.wav	1		
5	verification_failed.wav	1		
6	temperature_rise_warning.wav	1		
7	temperature_rise_alarm.wav	1		
8	temperature_range_alarm.wav	1		
9	temperature_diff_alarm.wav	1		
10	temperature_diff_warning.wav	1		
11	high_temperature_warning.wav	1		
12	fire_detected_please_process_immediately.wav	1		
13	smoking_is_prohibited_in_this_area.wav	1		

Armed UnArmed

	0	1	2	3	4	5	6	7	8	9	10	11	12	13	14	15	16	17	18	19	20	21	22	23	24
Sun																									
Mon																									
Tues																									
Wed																									
Thur																									
Fri																									
Sat																									

User can set the audio file manually. Click  to upload the audio file(The type should be WAV, size must be less than 250 Kb, the bit rate should be 128 kbps.), as shown in Figure 3-12.

Figure 3-12 Upload audio file



Flashlight Alarm: At “**Configuration > Thermal > Led Control Param**” interface, set the flashlight alarm mode. The Display Mode choose mode 5 (When alarm triggered, the Led light will keep on for 20s), the Led light will be on when the alarm is triggered. If the Led display mode is not set as Mode 5, the default status is flicker when the alarm is triggered.

Figure 3-13 Led control parameter

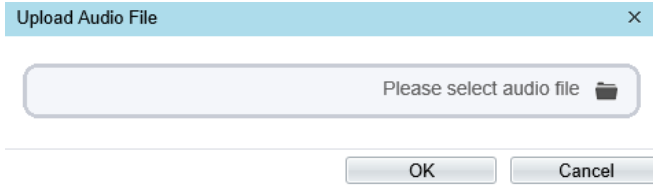
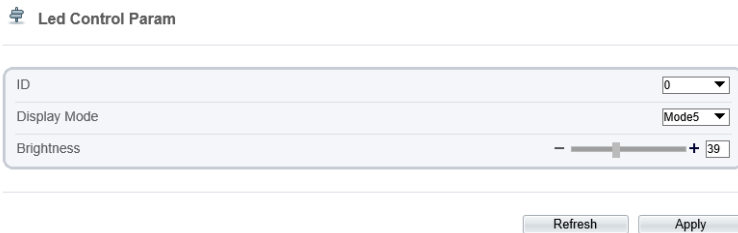

----End

3.6 Thermal Mapping

Thermal mapping is used to map accurately the location of detecting area to the visual channel. The mapping has three points, user can choose the right locations to map, the three points should not be too close.

NOTE

- The images have been calibrated before leaving the factory and can be used directly. If the highest temperature detection points are deviating on the visible light image, it needs to be re-calibrated.

Operation Procedure

Step 1 Choose **Configuration > Thermal > Thermal Mapping**, as shown in Figure 3-14.

Figure 3-14 Thermal Mapping Interface

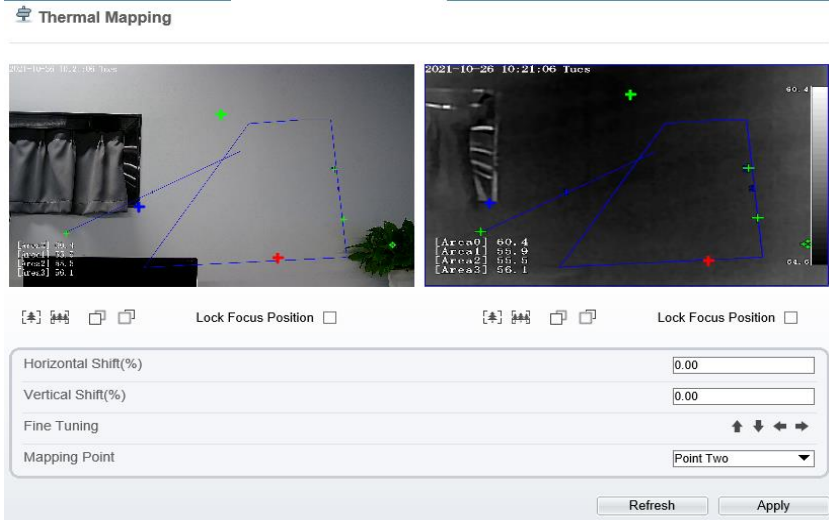

Step 2 Settings please refer to Table 3-8.

Table 3-8 Parameter of Thermal Mapping

Parameter	Description	Setting
Horizontal shift(%)	Adjust horizontal position of area which is on visual image.	[Setting method] Input value
Vertical shift(%)	Adjust vertical position of area which is on visual image.	[Setting method] Input value
Fine turning	Click the icon to adjust the position trifle.	[Setting method] Click
Mapping point	You need map three points at two channels. Points are correspond of each. The three points should cover most areas, and two points are located in the diagonal display of the picture. Point one is green cross. Point two is red cross. Point three is blue cross.	[Setting method] Select from drop list .

Step 3 Click **Apply**. The message "**Apply success**" is displayed, the system saves the settings.

----End

3.7 Defect Pixel Correction

Operation Procedure

Step 1 Choose **Configuration > Thermal > Defect Pixel Correction**.

The **Defect Pixel Correction** page is displayed, as shown in Figure 3-15.

If the image has a white dot as shown in figure, user can test the function to recover the defect pixel. Users should connect the technical support at this condition to make sure to apply.

Figure 3-15 Defect pixel correction



Step 2 Click the white point at image, click **Refresh** to recover the defect pixel, as shown in Figure 3-16.

Figure 3-16 Recover Defect Pixel



Step 3 Click **Apply**. The message "Apply success" is displayed, the system saves the settings.

----End

3.8 LED Control Param

Set the display mode and brightness of LED, as shown in Figure 3-17.

Figure 3-17 LED Control Param

 Led Control Param

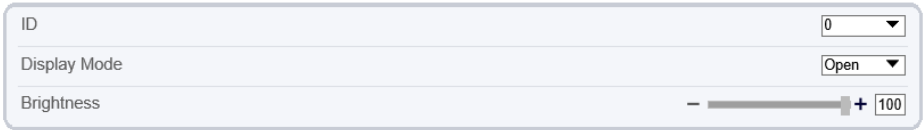

Table 3-9 LED Control Param

Parameter	Description	Setting
Display Mode	There are four modes can be chosen. Open: the LED is always lighting. Close: the LED is closed. Flicker: set the flicker interval, the LED will flicker as the set. Timing: the LED will lighting at the set time.	[Setting method] Select from drop-down list.
Brightness	The LDE's brightness	[Setting method] Drag the slider. [Default value] 100

----End

4 Visible Image Settings

4.1 Accessing Image Settings Interface

Procedure

Step 1 On the web, choose “**Configuration > Image Settings**” interface to set, as shown in Figure 4-1.

Figure 4-1 Image Settings

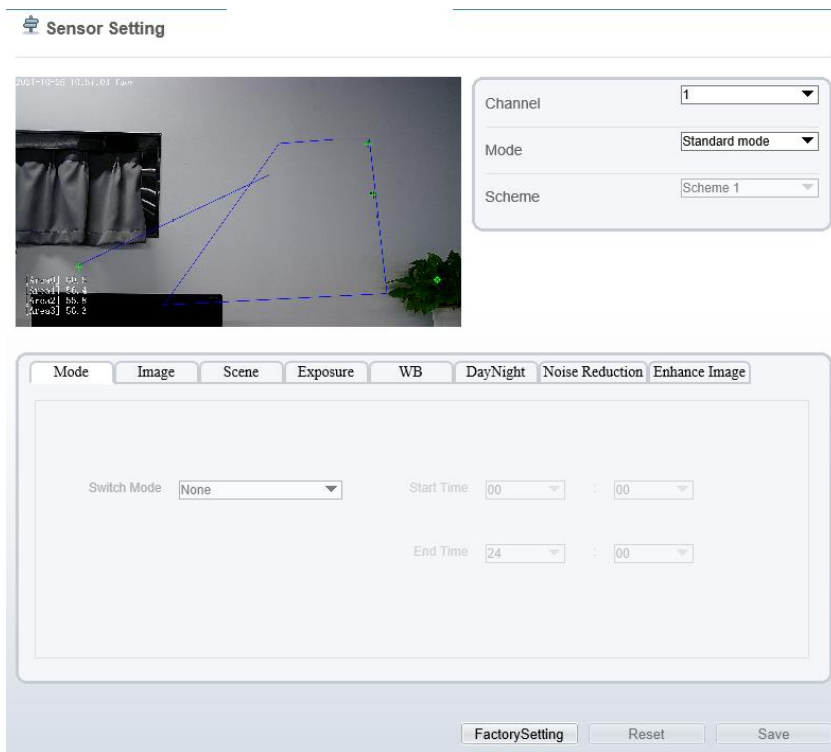

Step 2 Choose **Channel 1** to set visible channel’s image settings.

Step 3 Choose the scheme from drop-down list, there are four schemes can be setting.

 **NOTE**

- All image settings can be modified at debug mode. Click **Standard** on interface and choose **Debug Mode**.

----End

4.2 Mode

Step 1 Click **Standard mode** on Image Settings interface, and choose **Debug Mode**. As shown in Figure 4-2.

Figure 4-2 Mode

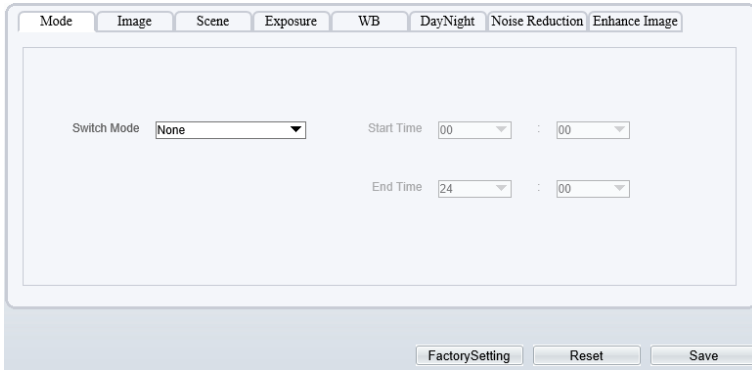

Step 2 Choose the switch mode from the drop-down list.

Step 3 Time mode: Set the Start Time, set the End Time.

Step 4 Click **Save**, the message "**Save succeed**" is displayed, the system saves the settings.

----End

4.3 Image

Figure 4-3 shows the Image tab page.

Figure 4-3 Image

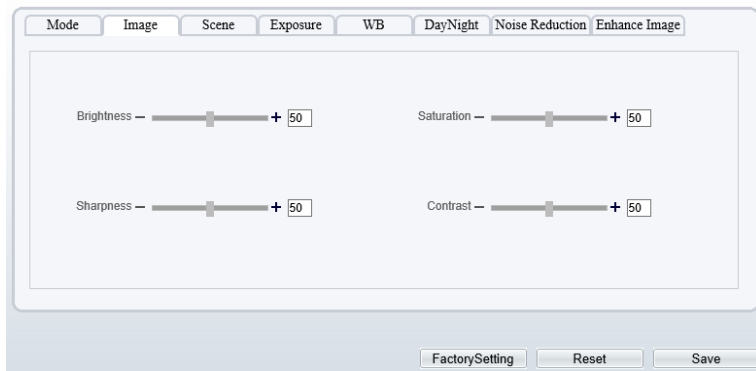

Table 4-1 describes the parameters on **Image** tab page.

Table 4-1 Parameters of Image

Parameter	Description	Configuration Method
Brightness	It indicates the total brightness of an image. As the value increases, the image becomes brighter.	[Setting method] Drag the slider. [Default value] 50
Sharpness	It indicates the border sharpness of an image. As the value increases, the borders become clearer, and the number of noise points increases.	[Setting method] Drag the slider. [Default value] 50
Saturation	It indicates the color saturation of an image. As the value increases, the image becomes more colorful.	[Setting method] Drag the slider. [Default value] 50
Contrast	It indicates the measurement of different brightness levels between the brightest white and darkest black in an image. The larger the difference range is, the greater the contrast; the smaller the difference range is, the smaller the contrast	[Setting method] Drag the slider. [Default value] 50

----End

4.4 Scene

Figure 4-4 shows the Scene tab page.

Figure 4-4 Scene

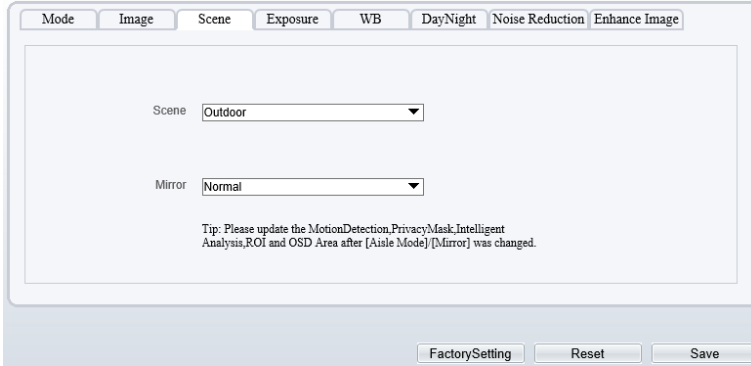

Table 4-2 describes the parameters on **Scene** tab page.

Table 4-2 Parameters of Scene

Parameter	Description	Configuration Method
Scene	Indoor or outdoor.	[Setting method] Select a value from the drop-down list. [Default value] Indoor
Mirror	It is used to select the pixel location of an image. <ul style="list-style-type: none"> • Normal: The image does not flip. • Horizontal: The image flips to the left and right. • Vertical: The image flips up and down. • Horizontal+ Vertical: The image rotates at 180 degrees. 	[Setting method] Select a value from the drop-down list. [Default value] Normal

----End

4.5 Exposure

Figure 4-5 shows the Exposure tab page.

Figure 4-5 Exposure

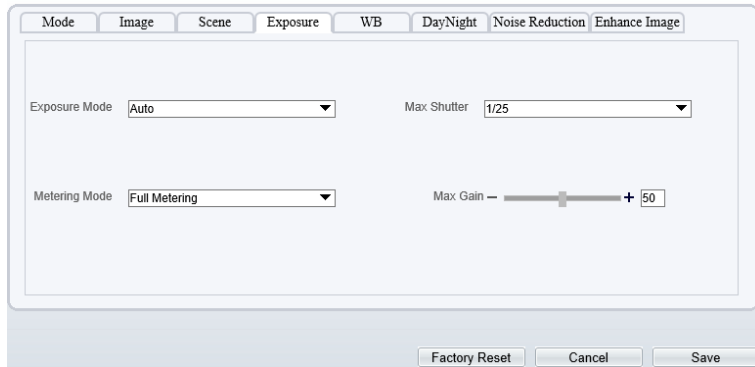

Table 4-3 describes the parameters on the Exposure setting tab page.

Table 4-3 Parameters of Exposure Setting

Parameter	Description	Configuration Method
Exposure Mode	<p>The exposure modes include:</p> <ul style="list-style-type: none"> • Auto: The system performs auto exposure based on the monitoring environment. • Manual: You can set Shutter Setting to fixed values manually. • Shutter Priority: You can set Shutter Setting to fixed values. The shutter and gain are automatically adjusted by the system. 	<p>[Setting method] Select a value from the drop-down list. [Default value] Auto</p>
Meter area	<p>Choose the area to meter, there are full metering, spot metering and partial metering.</p>	<p>[Setting method] Select a value from the drop-down list. [Default value] Full Metering</p>
Max Shutter	<p>It is valid in Iris Priority mode. You can select a maximum shutter speed. As the value increases, the image becomes brighter.</p>	<p>[Setting method] Select a value from the drop-down list. [Default value] 1/25</p>

Max gain	It indicates the maximum gain. The device automatically adjusts the gain based on the external light, and the gain is less than or equal to the value of this parameter.	[Setting method] Drag the slider. [Default value] 50
----------	--	--

----End

4.6 WB

Figure 4-6 shows the WB tab page.

Figure 4-6 WB

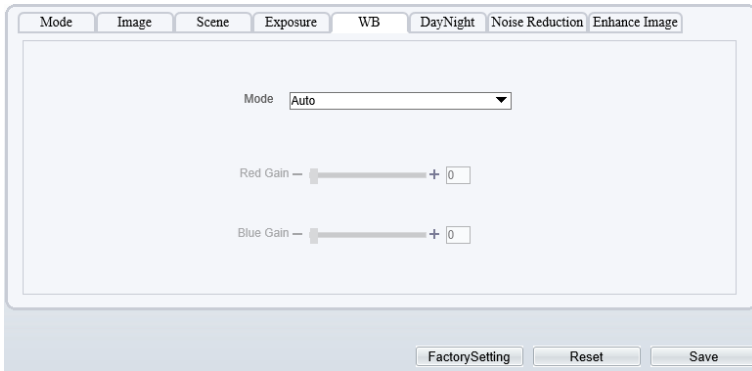

Table 4-4 describes the parameters on the WB tab page.

Table 4-4 Parameters of WB

Parameter	Description	Configuration Method
Mode	It is used to display the real color of a monitoring scenario when the color temperature changes. <ul style="list-style-type: none"> • Auto: camera adjusts automatically. • Tungsten: at tungsten lamp Environment. • Fluorescent: fluorescent environment. • Daylight: at daylight environment. • Shadow: at low light environment. • Manual: adjust red and blue gain manually. 	[Setting method] Select a value from the drop-down list. [Default value] Auto

----End

4.7 DayNight

Figure 4-7 shows the Day-Night tab page.

Figure 4-7 Day-Night

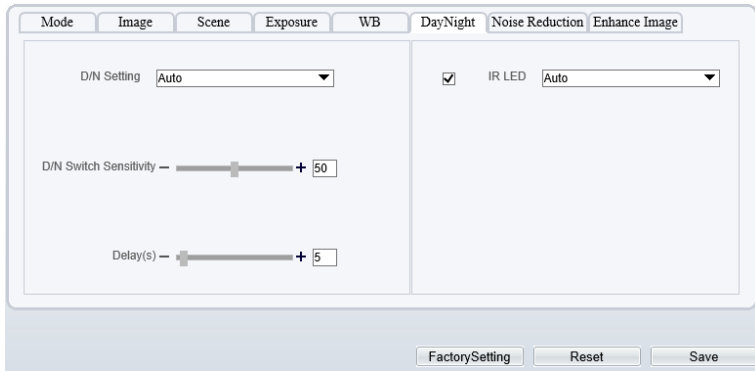

Table 4-5 describes the parameters on the Day-Night tab page.

Table 4-5 Parameters of Day Night

Parameter	Description	Configuration Method
<p>DayNight Mode</p>	<p>It can be set to Auto, Day Mode, Night Mode and Timing.</p> <ul style="list-style-type: none"> • Auto mode The image color is adjusted based on the day/night mode. In auto mode, the image switches between the colored state and the black and white state based on the brightness. In day mode, the image is colored. In night mode, the image is black and white. • Day mode The image is colored, and the filter is in the day state, preventing infrared light from entering the sensor. • Night mode The image is black and white, and the filter is in the night state, allowing all types of light to enter the sensor. • Timing Select time from the drop-down list by the “Day To Night Time” and “Night To Day Time”. 	<p>[Setting method] Select a value from the drop-down list. [Default value] Day Mode</p>
<p>Trans (D to N)</p>	<p>Day transit to night.</p>	<p>[Setting method] Drag the slider. [Default value] 50</p>
<p>Trans (N to D)</p>	<p>Night transit to day.</p>	<p>[Setting method] Drag the slider. [Default value] 50</p>
<p>Delay</p>	<p>N/A</p>	<p>[Setting method] Drag the slider. [Default value] 5</p>

IR LED	Tick to enable the IR LED, there are two modes can be chosen, auto and manual. At manual mode drag slider to adjust the value.	[Setting method] Select a value from the drop-down list. [Default value] Auto
--------	--	---

----End

4.8 Noise Reduction

Figure 4-8 shows the Noise Reduction tab page.

Figure 4-8 Noise Reduction

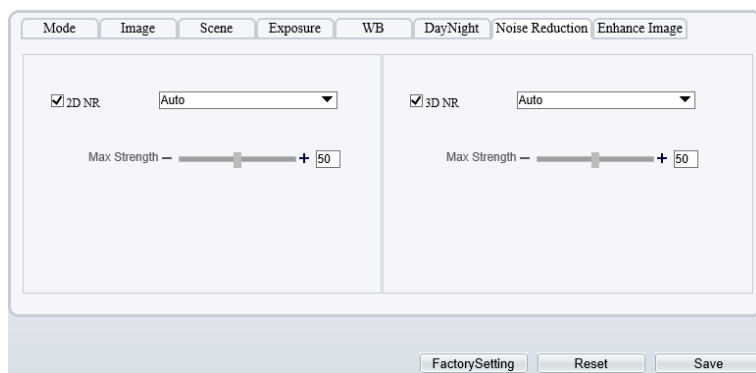

Table 4-6 describes the parameters on the Noise Reduction tab page.

Table 4-6 Parameters of Noise Reduction

Parameter	Description	Configuration Method
2D NR	Auto /manual, default value is auto. By comparing and screening the images of the two frames before and after, the noise point position is found out and gain control is carried out on them.	[Setting method] Drag the slider strength. [Default value] Auto / 50
3D NR	Auto /manual, default value is auto. The 3D digital noise reduction function can reduce the noise interference of the weak signal image.	[Setting method] Drag the slider of strength. [Default value] Auto / 50

----End

4.9 Enhance Image

Figure 4-9 shows the Enhance Image tab page.

Figure 4-9 Enhance Image

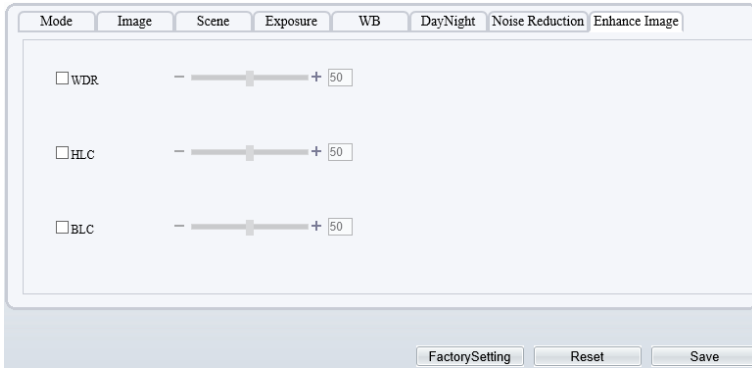



Table 4-7 describes the parameters on the Enhance Image tab page.

Table 4-7 Parameters of Enhance Image

Parameter	Description	Configuration Method
WDR	It is intended to provide clear image performance in strong backlight areas such as exterior light coming through a window or glass door. High contract light conditions are no longer a problem when you need to capture detailed images.	[Setting method] Drag the slider. [Default value] 50
HLC	It indicates reverse bright points in the picture to black. As an effective approach to recognize vehicle plate number at night, HLC function can detect any spotlight diffused by object-vehicle and compensate it for obtaining clearer image.	[Setting method] Drag the slider. [Default value] 50

BLC	<p>It indicates Back Light Compensation (BLC) automatically brings more detail to darker areas of an image when bright light shining from behind obscures it and provides perfect exposure for an object in front of very strong back light. The electronic shutter of the camera basically adjusts its exposure to try to allow for more light to be allowed in the darker areas.</p> <p> NOTE This parameter applies only to visible light.</p>	<p>[Setting method] Drag the slider. [Default value] 50</p>
-----	---	--

----End

5 Thermal Image Settings

5.1 Accessing the Image Settings Interface

Operation Procedure

Step 1 On the web choose “**Configuration > Image Settings**” interface to set, as shown in Figure 5-1.

Figure 5-1 Thermal Channel Image Settings

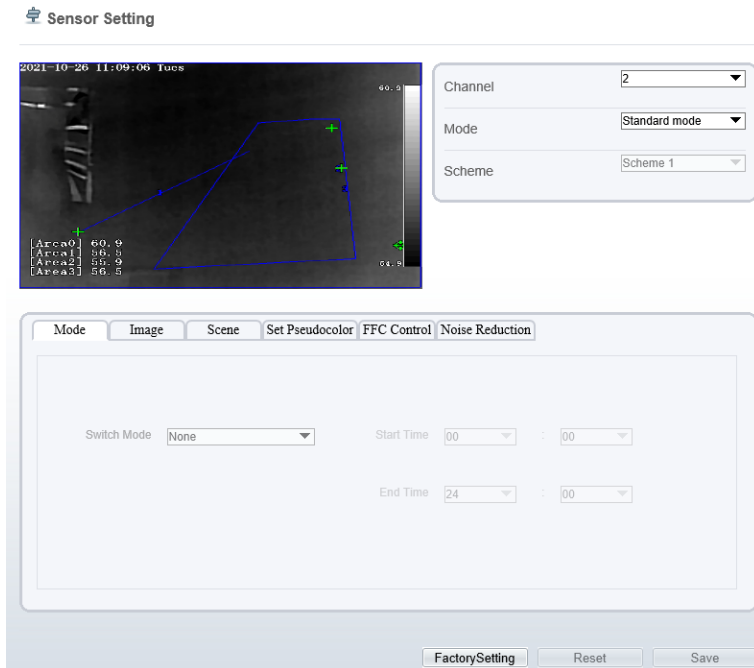

Step 2 Choose **Channel 2**. The thermal channel **Image Settings** is displayed.

Step 3 Choose the scheme from drop-down list, there are four schemes can be setting.

----End

5.2 Mode

Figure 5-2 shows the Mode interface.

Figure 5-2 Mode Interface

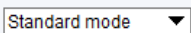

Operation Procedure

- Step 2 Click  on Image Settings interface, and choose Debug Mode.
- Step 3 Choose switch mode from the drop-down list
- Step 4 Time mode: Set the Start Time, set the End Time.
- Step 5 Click Save, the message " Save succeed " is displayed, the system saves the settings.

----End

5.3 Images

Figure 5-3 shows the **Image** setting interface.

Figure 5-3 Image Interface

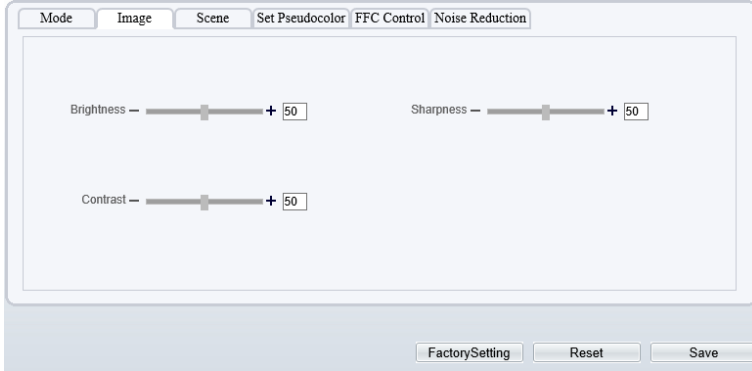

Step 2 Click **Standard** on Image Settings interface, and choose Debug Mode.

Step 3 Drag the slider to adjust parameter of image.

Step 4 Click Save, the message "Save succeed" is displayed, the system saves the settings.

 **NOTE**

- Brightness: It indicates the total brightness of an image. As the value increases, the image becomes brighter. It ranges from 0 to 100.
- Contrast: It indicates the contrast between the bright part and the dark part of an image. As the value increases, the contrast increases. It ranges from 0 to 100.
- Sharpness: It indicates the contrast between definition and edge sharpness. The higher value, the higher definition and greater distortion. It ranges from 0 to 100.

----End

5.4 Scene

Figure 5-4 shows the **Scene** setting interface.

Figure 5-4 Scene Interface



Step 2 Click **Standard** on Image Settings interface, and choose scene tab page.

Step 3 Choose mirror mode from drop-list.

Step 4 Click **Save**, the message "Save succeed" is displayed, the system saves the settings.



NOTE

- Mirror providing the selection of image pixel locations.
- Normal: the image is not flipped.
- Horizontal: the image is flipped left and right.
- Vertical: the image is flipped up and down.
- Horizontal + Vertical: the image is rotated at 180 degree.

----End

5.5 Set Pseudocolor

Figure 5-5 shows the **Set pseudocolor** setting interface.

Figure 5-5 Set Pseudocolor Interface

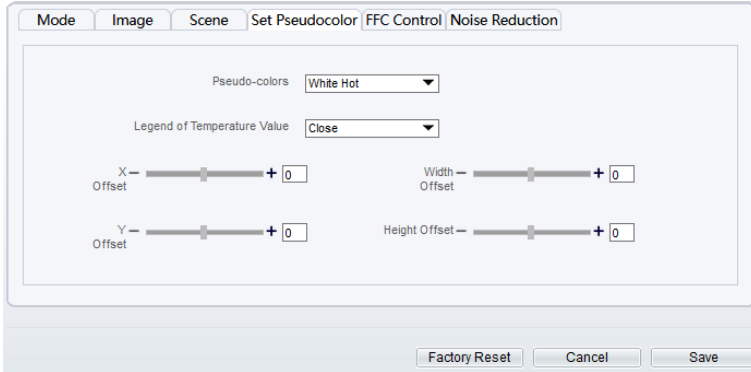

- Step 2 Click **Standard** on Image Settings interface, and choose set pseudo color.
- Step 3 Choose polarity/LUT mode from drop-list.
- Step 4 Enable or disable the legend of temperature value.
- Step 5 Adjust location of Mix Stream.(Enable Mix Stream, at Configuration > Thermal > Temperature Parameters > Advanced interface.)
- Step 6 Click **Save**, the message "Save succeed" is displayed, the system saves the settings.

NOTE

- The temperatures of the temperature fields detected by the thermal imaging camera are separately mapped to values ranging from 0 to 255 by the algorithm. In the black/white display mode, this range is converted to the gray scale tones. For example, 0 indicates completely black, and 255 indicates completely white. The temperature field of the scene is converted to images by using the grayscale ranging from 0 to 255. Different polarity modes can be converted to different display images. The most common setting is white hot (a hotter object is displayed brighter than a colder object) or black hot (a hotter object is displayed darker than a colder object). The difference between two modes lies in that the temperatures corresponding to the darker one and the lighter one are reversed. Other modes include rainbow, ironbow, HSV, autumn, bone and so on.

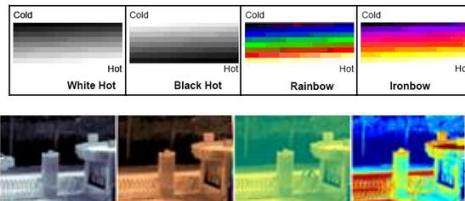

5.6 FFC Control

Figure 5-6 shows the **FFC control** interface.

Figure 5-6 FFC Control Interface

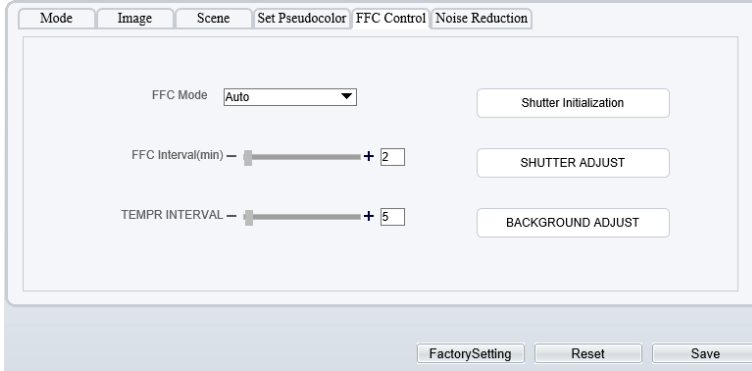

Table 5-1 lists the parameters on the FFC Control interface.

Table 5-1 Parameters of the FFC Control Interface

Parameter	Description	Setting
FFC Mode	<p>The internal of the thermal imaging camera may comprise the mechanical action correction mechanism that can periodically improve the image quality. This component is called flat field correction (FFC). When controlling the FFC, the FFC shields the sensor array, so that each portion of the sensor can collect uniform temperature fields (flat field). By means of FFC, the camera can update the correction coefficients to output more uniform images. Throughout the FFC process, the video image is frozen for two seconds and a static-frame image is displayed. After the FFC is complete, the image is automatically recovered. Repeated FFC operations can prevent the grainy and image degradation problems. The FFC is especially important when the temperature of the camera changes. For example, after the camera is powered on or the ambient temperature is changed, you should immediately perform the FFC.</p> <p>Auto: In the Automatic FFC mode, the camera performs FFC whenever its temperature changes by a specified amount or at the end of a specified period of time (whichever comes first). When this mode is selected, the FFC interval (minutes) ranges from 5 to 30 minutes. The temperature change of the camera is based on the temperatures collected by the internal</p>	<p>[How to set] Select from the drop-down list box. [Default value] Auto</p>

Parameter	Description	Setting
	<p>temperature probe. The temperature of the camera sharply changes when the camera is powered on. The FFC is relatively frequent, which is normal.</p> <p>Manual: In the manual FFC mode, the camera does not automatically perform the FFC based on the temperature change or the specified period. You can press the Do FFC button to select the manual FFC mode. When you feel that the image is obviously degraded but the automatic FFC is not performed, you can use the manual FFC function to check whether the image quality can be improved.</p>	
FFC interval (min)	In the automatic FFC mode, the FFC interval ranges from 10 to 255 minutes. When the time reach to setting value, the camera does shutter adjust operation automatically.	<p>[How to set] Select by dragging the slider. [Default value] 15</p>
Tempr interval	In the automatic FFC mode, the tempr interval value ranges from 5 to 255 degree centigrade. When the time reach to setting value, the camera does background adjust operation automatically.	<p>[How to set] Select by dragging the slider. [Default value] 5</p>
Shutter initialization	Click the icon and shutter will be initialized	Manually
Shutter adjust	Click the icon and camera perform the action.	Manually
Background adjust	Click the icon and camera perform the action.	Manually

----End

5.7 Noise Reduction

Figure 5-7 shows the **Noise Reduction** interface.

Figure 5-7 Noise Reduction Interface



Table 5-2 lists the Noise Reduction parameters.

Table 5-2 Parameters of Noise Reduction Interface

Parameter	Description	Setting
2DNR	Decrease the image noise.	[How to set] Select from the drop-down list box. [Default value] Close
3DNR	Decrease the image noise.	[How to set] Select from the drop-down list box. [Default value] Close

----End

6 Intelligent Analysis

There are many kinds of intelligent analysis, such as **Intrusion**, **Single Line Crossing**, **Double Line Crossing**, **Multi-Loitering**, **Retrograde**, **People Counting**, **Enter Area**, **Leave Area**. The parameters of these analysis alarm are roughly similar, so we will describe someone in detail as a reference.

Intrusion: The Intrusion function refers to that an alarm is generated when target objects (such as person, car, and both person and car) enter the deployment area.

Single Line Crossing: A Single Line Crossing is a line that is set at a concerned position within the monitored field of view and specifies the forbidden travel direction; An alarm is generated when the targets of specified types (such as person or car) cross this line.

Double Line Crossing: Double Line Crossing refers to two lines that are set at a concerned special position within the field of view and specify the forbidden travel direction. When the targets of specified types (such as person or car) move along the set travel direction and cross these lines in a certain order (line 1 followed by line 2) in pass max time, an alarm is generated.

Multi-Loitering: Multi-Loitering allows setting the shortest loitering time for multiple targets of specified type (such as person or car) within the deployment area in the field of view. When the loitering time of the multiple targets within this area meets the set shortest loitering time, an alarm is generated.

Retrograde: Retrograde allows setting the travel direction criteria for a target within an area on the video screen. When a target of specified type (such as people or car) within this area moves in the set travel direction, an alarm is generated.

People Counting: Users can draw line to count the number of people in the special area.

Enter Area: The enter area refers to that an alarm is generated when a target enters the deployment area at the valid time.

Leave Area: The leave area refers to that an alarm is generated when a target leaves the deployment area at the valid time.

6.1 Intrusion

Procedure

Step 1 Select **Configuration > Intelligent Analysis > Intrusion** to access the **Intrusion** interface, as shown in Figure 6-1.

Figure 6-1 Intrusion Setting Interface

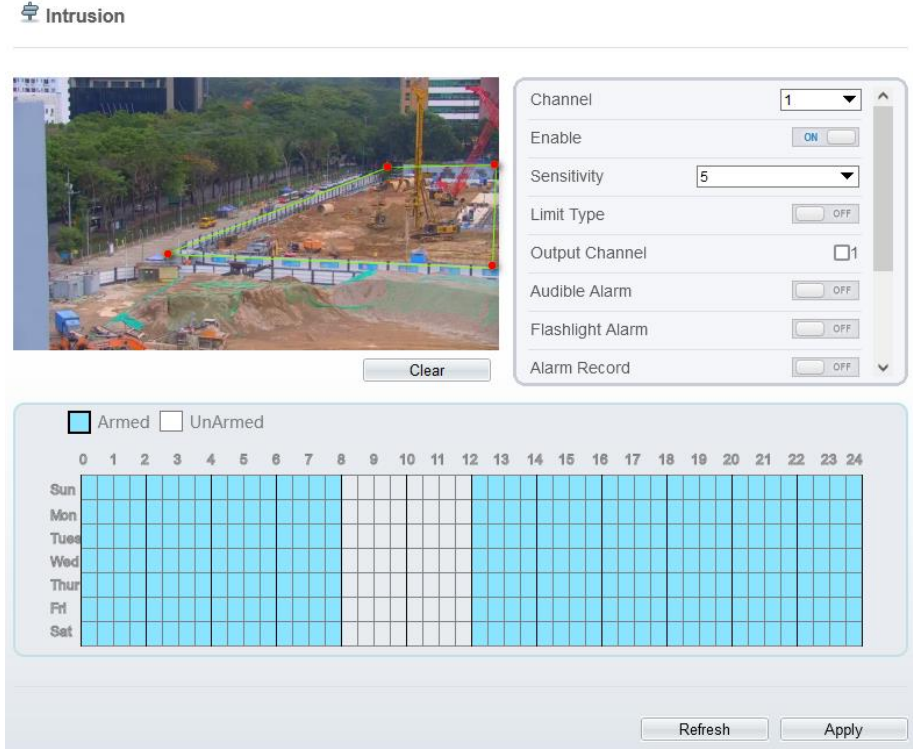

Step 2 Set all parameters for Intrusion. The table describes the specific parameters.

Table 6-1 Intrusion Parameter Description

Parameter	Description	Setting
Channel	Channel 1: visible. Channel 2: thermal.	Choose one channel to set.
Enable	Enable the button to enable the alarm.	[How to set] Click Enable to enable. [Default value] OFF
Sensitivity	The sensitivity of detecting smoker, when the value is high, the alarm can be triggered easily, but the accuracy will be lower.	[How to set] Choose from the drop-down list [Default value] 5

Parameter	Description	Setting
Limit Type	Effective alarms are set based on target type, with options of Person or Car, person, car. When the device is used indoors, because of small space and large targets, to avoid wrong alarms are triggered b person even if car is selected, it is recommended to set the target type to person for indoor use.	[How to set] Click to enable Limit Target Type. [Default value] OFF
Output Channel	If you check to set the Output Channel and the device is connected to an external alarm indicator, the alarm indicator signals when an alarm is triggered.	[How to set] Click to select an ID.
Audible alarm	Enable, when an alarm occurs, it will play audio to alarm. Choose the audible alarm file (set at the “ Configuration > Alarm > Audible Alarm Output ”).	[How to set] Click to enable Audible alarm [Default value] OFF
Flashlight alarm	Enable, when it is triggered alarm, it flashes the light. But when users set the display mode to Mode 5 at “ Configuration > Thermal > Led Control Param ”interface, the lighth will be always on for 15s, not flash when it is alarm.	[How to set] Click to enable Flashlight Alarm. [Default value] OFF
SMTP	Enable the button to enable SMTP server.	[How to set] Click to enable SMTP. [Default value] OFF
FTP Upload	Enable the button to enable File Transfer Protocol.	[How to set] Click to enable FTP Upload. [Default value] OFF
Video Stream Draw Line	Enable the button, the draw line will show at live video when the stream is stream 2.	[How to set] Click to enable FTP Upload. [Default value] OFF

Step 3 Set a deployment area. Move the cursor to the drawing interface and click to generate a point, move the cursor to draw a line, and then click to generate another point. This is how a line is generated. In this way, continue to draw lines to form any shape, and right-click to finish line drawing.



NOTE

- A drawn line cannot cross another one, or the line drawing fails.
- Any shape with 32 sides at most can be drawn.
- The quantity of deployment areas is up to 8.

Step 4 Set deployment time.

Method 1: Click left mouse button to select any time point within 0:00-24:00 from
Click the armed icon Armed to set the arming time. Click the Unarmed icon UnArmed to set the unarming time.

Method 1: Click left mouse button to select any time point within 0:00-24:00 from Monday to Sunday.

Method 2: Hold down the left mouse button, drag and release mouse to select the deployment time within 0:00-24:00 from Monday to Sunday.

Deleting deployment time: Click UnArmed to delete the selected deployment time. The methods are same as set deployment time.



NOTE

When you select time by dragging the cursor, the cursor cannot be moved out of the time area. Otherwise, no time can be selected.

Figure 6-2 Deployment Time Setting Interface

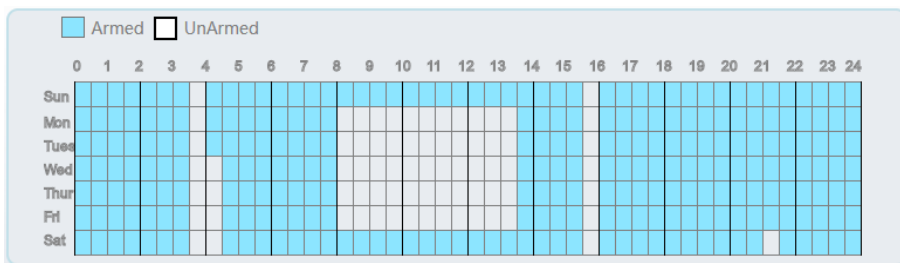

Step 5 Click **Apply** to save the settings.

----End

6.2 Single Line Crossing

Procedure

Step 1 Select **Configuration > Intelligent Analysis > Single Line Crossing** to access the **Single Line Crossing** setting interface, as shown in Figure 6-3.

Figure 6-3 Single Line Crossing Setting Interface

Single Line Crossing

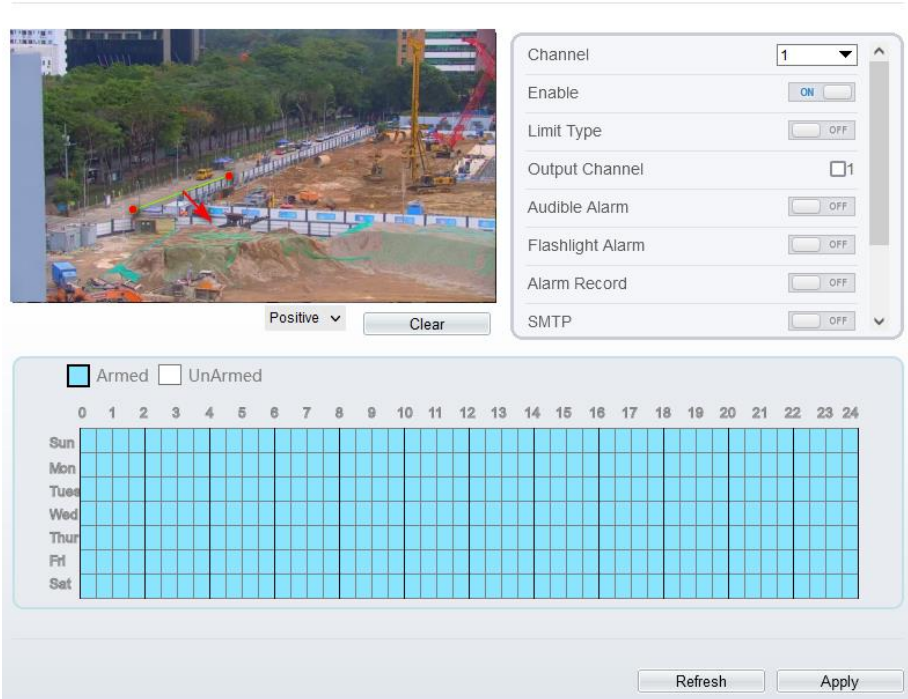

Step 2 Set all parameters for the Single Line Crossing. Table 6-2 describes the specific parameters.

Table 6-2 Parameters of Single Line Crossing

Parameter	Description	Setting
Channel	Channel 1: visible. Channel 2: thermal.	[How to set] Choose one channel to set.

Parameter	Description	Setting
Enable	Enable the button to enable the alarm.	[How to set] Click Enable to enable. [Default value] OFF
Limit Type	Effective alarms are set based on target type, with options of Person or Car, person, car. When the device is used indoors, because of small space and large targets, alarms are triggered by person sometimes even if car is selected, leading to false alarms. It is recommended to set the target type to person for indoor use.	[How to set] Click to enable Limit Target Type. [Default value] OFF
Output Channel	If you check to set the Output Channel and the device is connected to an external alarm indicator, the alarm indicator signals when an alarm is triggered.	[How to set] Click to select an ID.
Audible alarm	Enable, when an alarm occurs, it will play audio to alarm. Choose the audible alarm file (set at the “ Configuration > Alarm > Audible Alarm Output ”).	[How to set] Click to enable Audible alarm [Default value] OFF
Flashlight alarm	Enable, when it is triggered alarm, it flashes the light. But when users set the display mode to Mode 5 at “ Configuration > Thermal > Led Control Param ” interface, the lighth will be always on for 15s, not flash when it is alarm.	[How to set] Click to enable Flashlight Alarm. [Default value] OFF
SMTP	Enable the button to enable SMTP server.	[How to set] Click to enable SMTP. [Default value] OFF
FTP Upload	Enable the button to enable File Transfer Protocol.	[How to set] Click to enable FTP. [Default value] OFF

Parameter	Description	Setting
Video Stream Draw Line	Enable the button to enable Video Stream Draw Line, the setting area frame will show on live video.	[How to set] Click to enable Video Stream Draw Line. [Default value] OFF

Step 3 Set a deployment area:

Draw a line: Move the cursor to the drawing interface, hold down the left mouse button, and move the cursor to draw a line. When you release the left mouse button, a Single Line Crossing is generated.

Setting a Single Line Crossing: Click a line (and the trip line turns red) to select the Single Line Crossing and set its direction as Positive, Reverse or Bidirectional, or delete the selected line. You can also press and hold left mouse button at the endpoint of a Single Line Crossing and move the mouse to modify the position and length of this Single Line Crossing. You can right-click to delete the Single Line Crossing.



NOTE

- Try to draw the Single Line Crossing in the middle, because the recognition of a target takes time after target appearance on the screen and an alarm is generated only when the object is recognized to have crossed the Single Line Crossing.
- The Single Line Crossing which detects person foot as the recognition target cannot be too short, because a short Single Line Crossing tends to miss targets.

Step 4 Set deployment time.

Step 5 Click **Apply** to save the settings.

---End

6.3 Double Line Crossing

Procedure

Step 1 Select **Configuration > Intelligent Analysis > Double Line Crossing** to access the **Double Line Crossing** setting interface, as shown in Figure 6-4.

Figure 6-4 Double Line Crossing Setting Interface

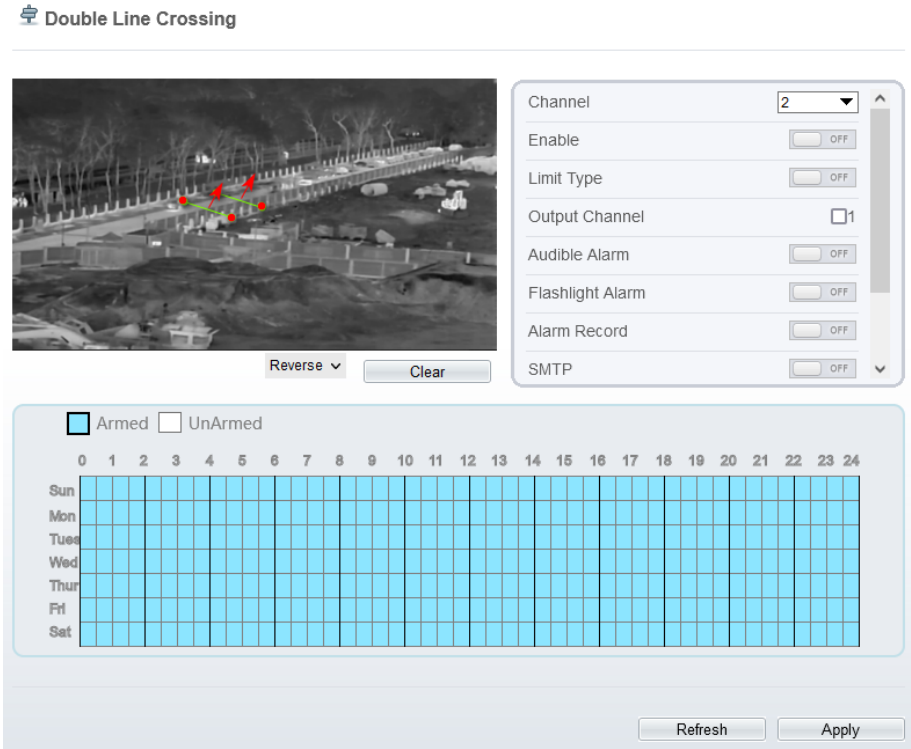

Step 2 Set all parameters for the Double Line Crossing. Table 6-3 describes the specific parameters.

Table 6-3 Description of Parameters for Double Line Crossing

Parameter	Description	Setting
Enable	Enable the button to enable the alarm.	[How to set] Click to enable. [Default value] OFF
Limit Type	Effective alarms are set based on target type, with options of Person or Car, person, car. When the device is used indoors, because of small space and large targets, alarms are triggered by person sometimes even if car is selected, leading to false alarms. It is recommended to set the target type to person for indoor use.	[How to set] Click to enable Limit Target Type. [Default value] OFF

Parameter	Description	Setting
Output Channel	If you check to set the Output Channel and the device is connected to an external alarm indicator, the alarm indicator signals when an alarm is triggered.	[How to set] Click to select an ID.
Audible alarm	Enable, when an alarm occurs, it will play audio to alarm. Choose the audible alarm file (set at the “ Configuration > Alarm > Audible Alarm Output ”).	[How to set] Click to enable Audible alarm [Default value] OFF
Flashlight alarm	Enable, when it is triggered alarm, it flashes the light. But when users set the display mode to Mode 5 at “ Configuration > Thermal > Led Control Param ”interface, the lighth will be always on for 15s, not flash when it is alarm.	[How to set] Click to enable Flashlight Alarm. [Default value] OFF
SMTP	Enable the button to enable SMTP server. Details please refer to chapter 10.5	[How to set] Click to enable SMTP. [Default value] OFF
FTP Upload	Enable the button to enable File Transfer Protocol. Details please refer to chapter 10.6.	[How to set] Click to enable FTP. [Default value] OFF
Video Stream Draw Line	Enable the button, the draw line will show at live video when the stream is stream 2.	[How to set] Click to enable Video Stream Draw Line. [Default value] OFF

Step 3 Set a deployment area.

Draw a line: Move the cursor to the drawing interface, hold down the left mouse button, and move the cursor to draw two lines. When you release the left mouse button, two numbered virtual fences are generated. Choose either of the Double Line Crossing to set the direction to Positive or Reverse.

Set Double Line Crossing: Click one of the Double Line Crossing (and the virtual fence turns red) to select this virtual fence and set the direction to **Positive** or **Reverse**, or delete the selected line. You can also press and hold left mouse button at the endpoint of a

virtual fence and move the mouse to modify the position and length of this virtual fence. You can right-click to delete the Double Line Crossing.

**NOTE**

- The two lines are in sequential order. An alarm is generated only when a target crosses virtual fence 1 and then virtual fence 2 within the set maximum passing time.
- Try to draw Double Line Crossing in the middle, because the recognition of a target takes time after target appearance on the screen and an alarm is generated only when the object is recognized to have crossed the Double Line Crossing.
- The Double Line Crossing which detect person foot as the recognition target cannot be too short, because short Double Line Crossing tend to miss targets.

Step 4 Set deployment time.

Step 5 Click **Apply** to save the settings.

----End

6.4 People Counting

Procedure

Step 1 Select **Intelligent Analysis > People Counting** to access the **People Counting** setting interface, as shown in Figure 6-5.

Figure 6-5 People counting

📷 People Counting

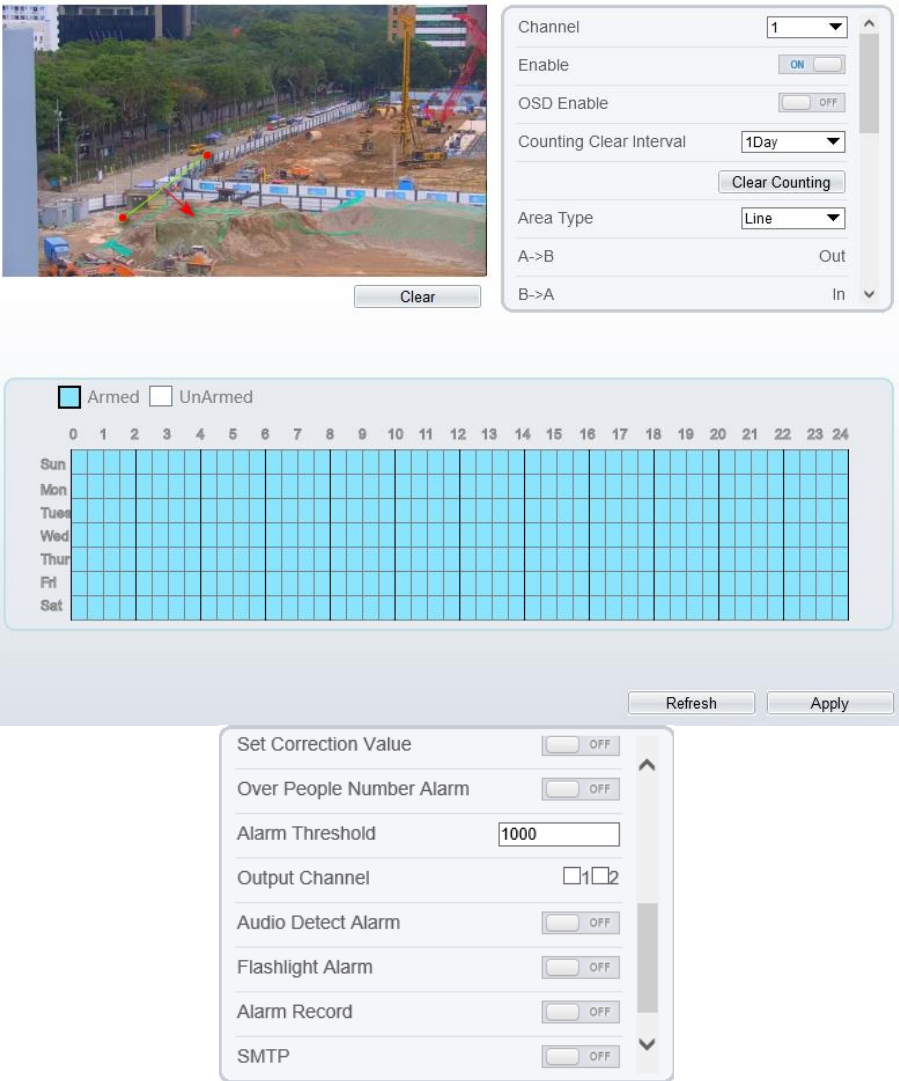

Channel: 1

Enable: ON

OSD Enable: OFF

Counting Clear Interval: 1Day

Clear Counting

Area Type: Line

A->B: Out

B->A: In

Clear

Armed UnArmed

	0	1	2	3	4	5	6	7	8	9	10	11	12	13	14	15	16	17	18	19	20	21	22	23	24
Sun																									
Mon																									
Tues																									
Wed																									
Thur																									
Fri																									
Sat																									

Refresh Apply

Set Correction Value: OFF

Over People Number Alarm: OFF

Alarm Threshold: 1000

Output Channel: 1 2

Audio Detect Alarm: OFF

Flashlight Alarm: OFF

Alarm Record: OFF

SMTP: OFF

Step 2 Set all parameters for People Counting. Table 6-4 describes the specific parameters.

Table 6-4 Parameters of people counting

Parameter	Description	Setting
Channel	Channel 1: visible. Channel 2: thermal.	[How to set] Choose one channel to set.
Enable	Enable the button to enable the alarm.	[How to set] Click Enable to enable. [Default value] OFF
OSD Enable	Enable the OSD, the count data will show on live video screen.	[How to set] Click Enable to enable. [Default value] OFF
Counting Clear Interval	The camera will clear counting data at the setting interval. Click the “Clear Counting”, clearing the data immediately.	[How to set] Choose from drop-down list. [Default value] 1 Day
Area Type	Draw a line on live video screen. The label of A and B indicate out and in.	[How to set] Choose from drop-down list. [Default value] Line
Set Correction Value	Enable, set the count correction value, it can be positive or negative. For example, if there are 30 people enter the area before counting, input 30 to correct. If 30 people go out the area, input -30.	[How to set] Enable /Input a value in the area box. [Default value] 0
Over People Number Alarm	Enable, when the counting number reaches the threshold value, an alarm is triggered.	[How to set] Click Enable to enable. [Default value] OFF
Alarm Threshold	The threshold of enable alarm.	[How to set] Enable /Input a value in the area box. [Default value] 1000

Parameter	Description	Setting
Output Channel	If you check to set the Output Channel and the device is connected to an external alarm indicator, the alarm indicator signals when an alarm is triggered.	[How to set] Click to select an ID.
Audible alarm	Enable, when an alarm occurs, it will play audio to alarm. Choose the audible alarm file (set at the “ Configuration > Alarm > Audible Alarm Output ”).	[How to set] Click to enable Audible alarm [Default value] OFF
Flashlight alarm	Enable, when it is triggered alarm, it flashes the light. But when users set the display mode to Mode 5 at “ Configuration > Thermal > Led Control Param ” interface, the lighth will be always on for 15s, not flash when it is alarm.	[How to set] Click to enable Flashlight Alarm. [Default value] OFF
SMTP	Enable the button to enable SMTP server. The parameters of SMTP can be set at Configuration > Network Service > SMTP interface.	[How to set] Click to enable SMTP. [Default value] OFF
FTP Upload	Enable the button to enable File Transfer Protocol. The parameters of FTP can be set at Configuration > Network Service > FTP interface.	[How to set] Click to enable FTP Upload. [Default value] OFF
Video Stream Draw Line	Enable the button to enable Video Stream Draw Line, the setting area frame will show on live video.	[How to set] Click to enable Video Stream Draw Line. [Default value] OFF

Step 3 Set a deployment area.

Move the cursor to the drawing interface and click to generate a point, move the cursor to draw a line, and then click to generate another point. This is how a line is generated. In this way, continue to draw lines to form any shape, and right-click to finish line drawing.

Step 4 Set deployment time.

Step 5 Click **Apply** to save the settings

----End

7 Advanced Intelligent Analysis

At the advanced intelligent analysis interface, users can set the parameters of smoker detection, smoke and flame detection, and fire spot detection. Enable the linkage actions, the alarm information can be sent to user by the linkage.

The advanced intelligent analysis can be used for detecting the smoking, if someone smoke in the indoor where smoking is forbidden.

Smoke and Flame Detection can be used for detecting smoke and fire, it can send alarm information to avoid fire getting worse.

Fire Spot Detection can be used for finding the catching fire to quickly operate to extinguish.

7.1 Smoker Detection

Description

The smoker detection function refers to that an alarm is generated when someone is smoking or generating spark at the deployment area.

Procedure

Step 1 Select **Configuration > Advanced Intelligent Analysis > Smoker Detection** to access the **Smoker Detection** interface, as shown in Figure 7-1.

Figure 7-1 Smoker detection interface

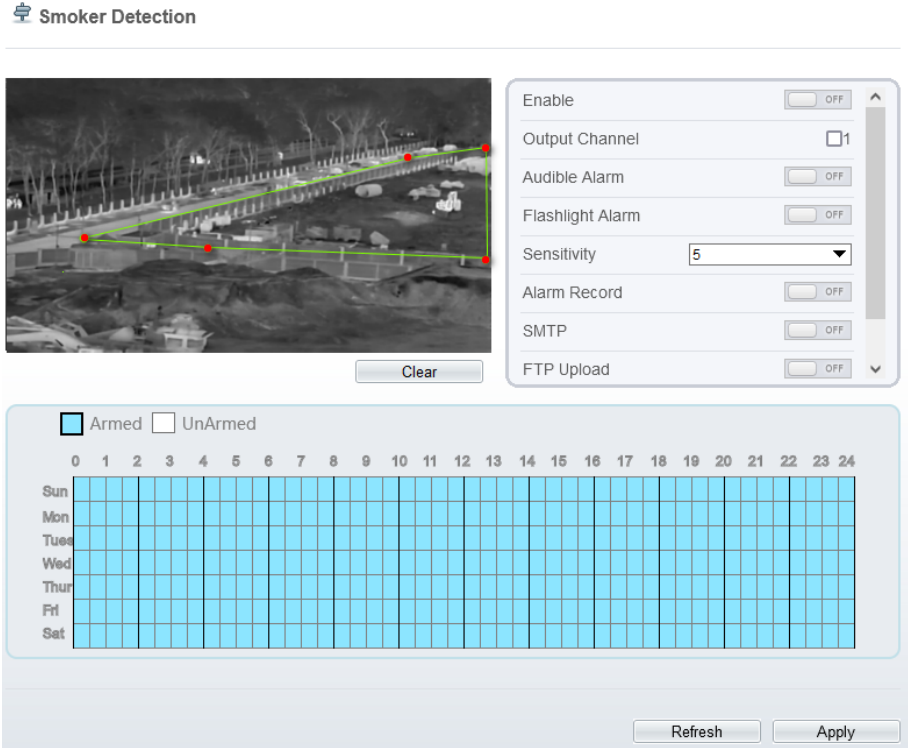

Step 2 Set all parameters for Smoker Detection. Table 7-1 describes the specific parameters.

Table 7-1 Parameters of smoker detection

Parameter	Description	Setting
Enable	At thermal channel, Enable the button to enable the alarm.	[How to set] Click Enable to enable. [Default value] OFF
Output Channel	If you check to set the Output Channel and the device is connected to an external alarm indicator, the alarm indicator signals when an alarm is triggered.	[How to set] Click to select an ID.

Parameter	Description	Setting
Audible alarm	Enable, when an alarm occurs, it will play audio to alarm. Choose the audible alarm file (set at the “ Configuration > Alarm > Audible Alarm Output ”).	[How to set] Click to enable Audible alarm [Default value] OFF
Flashlight alarm	Enable, when it is triggered alarm, it flashes the light. But when users set the display mode to Mode 5 at “ Configuration > Thermal > Led Control Param ”interface, the lighth will be always on for 15s, not flash when it is alarm.	[How to set] Click to enable Flashlight Alarm. [Default value] OFF
Sensitivity	The sensitivity of detecting smoker, when the value is high, the alarm can be triggered easily, but the accuracy will be lower.	[How to set] Choose from the drop-down list [Default value] 5
SMTP	Enable the button to enable SMTP serve.	[How to set] Click to enable SMTP. [Default value] OFF
FTP Upload	Enable the button to enable File Transfer Protocol.	[How to set] Click to enable FTP Upload. [Default value] OFF
Video Stream Draw Line	Enable the button to enable Video Stream Draw Line, the setting area frame will show on live video.	[How to set] Click to enable Video Stream Draw Line. [Default value] OFF

Step 3 Set a deployment area. Move the cursor to the drawing interface and click to generate a point, move the cursor to draw a line, and then click to generate another point. This is how a line is generated. In this way, continue to draw lines to form any shape, and right-click to finish line drawing.



NOTE

- A drawn line cannot cross another one, or the line drawing fails.
- Any shape with 32 sides at most can be drawn.
- The quantity of deployment areas is up to 8.

Step 4 Set deployment time.

Step 5 Click **Apply** to save the settings.

----End

7.2 Smoke and Flame Detection

Description

The smoke flame detection function refers to that an alarm is generated when something is smoking or generating flame at the deployment area.

Procedure

Step 1 Select **Configuration > Advanced Intelligent Analysis > Smoke and Flame Detection** to access the Smoke and Flame Detection interface, as shown in Figure 7-2.

Figure 7-2 Smoke and flame detection interface

 Smoke and Flame Detection

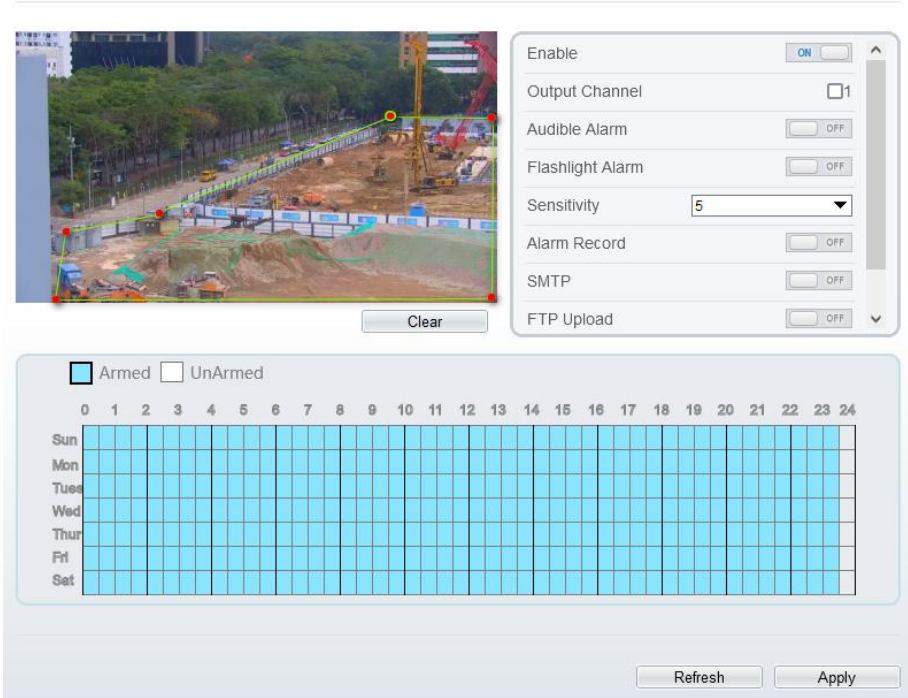

Step 2 Set all parameters for Smoke and Flame Detection. Table 7-2 describes the specific parameters.

Table 7-2 Smoke flame detection description

Parameter	Description	Setting
Enable	At thermal channel, Enable the button to enable the alarm.	[How to set] Click Enable to enable. [Default value] OFF
Output Channel	If you check to set the Output Channel and the device is connected to an external alarm indicator, the alarm indicator signals when an alarm is triggered.	[How to set] Click to select an ID.

Parameter	Description	Setting
Audible alarm	Enable, when an alarm occurs, it will play audio to alarm. Choose the audible alarm file (set at the “ Configuration > Alarm > Audible Alarm Output ”).	[How to set] Click to enable Audible alarm [Default value] OFF
Flashlight alarm	Enable, when it is triggered alarm, it flashes the light. But when users set the display mode to Mode 5 at “ Configuration > Thermal > Led Control Param ”interface, the lighth will be always on for 15s, not flash when it is alarm.	[How to set] Click to enable Flashlight Alarm. [Default value] OFF
Sensitivity	The sensitivity of detecting smoker, when the value is high, the alarm can be triggered easily, but the accuracy will be lower.	[How to set] Choose from the drop-down list [Default value] 5
SMTP	Enable the button to enable SMTP serve.	[How to set] Click to enable SMTP. [Default value] OFF
FTP Upload	Enable the button to enable File Transfer Protocol.	[How to set] Click to enable FTP Upload. [Default value] OFF
Video Stream Draw Line	Enable the button to enable Video Stream Draw Line, the setting area frame will show on live video.	[How to set] Click to enable Video Stream Draw Line. [Default value] OFF

Step 3 Set a deployment area. Move the cursor to the drawing interface and click to generate a point, move the cursor to draw a line, and then click to generate another point. This is how a line is generated. In this way, continue to draw lines to form any shape, and right-click to finish line drawing.



NOTE

- A drawn line cannot cross another one, or the line drawing fails.
- Any shape with 32 sides at most can be drawn.
- The quantity of deployment areas is up to 8.

Step 4 Set deployment time.

Step 5 Click **Apply** to save the settings.

----End

7.3 Fire Spot Detection

Description

The fire spot detection function refers to that an alarm is generated when something is on fire at the deployment area.

Procedure

Step 1 Select **Configuration > Advanced Intelligent Analysis > Fire Spot Detection** to access the **Fire Spot Detection** interface, as shown in Figure 7-3

Figure 7-3 Fire spot detection interface

 Fire Spot Detection

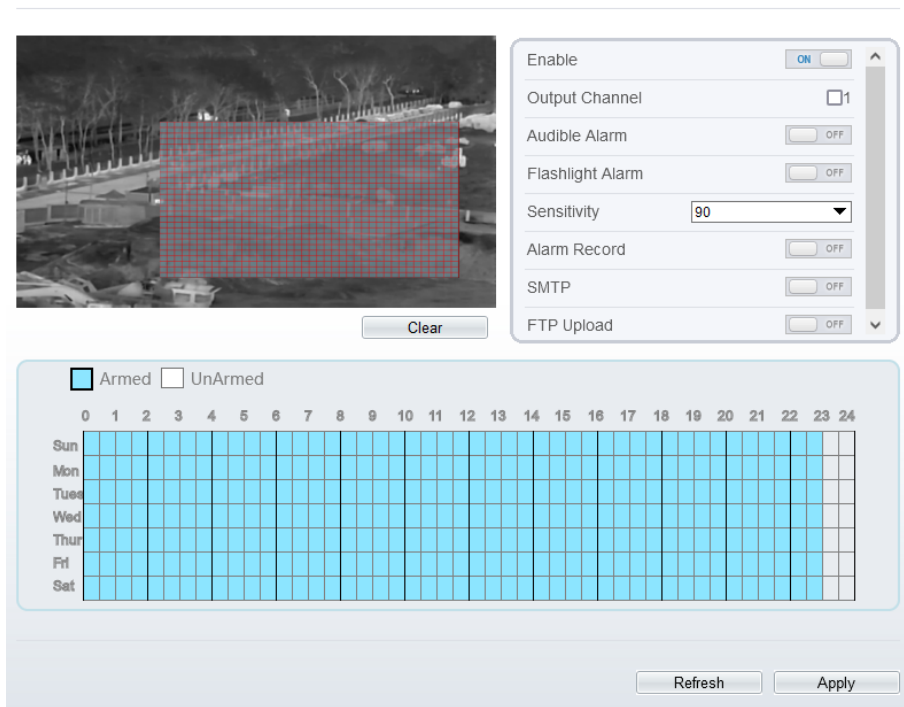

Step 2 Set all parameters for Fire Spot Detection. Table 7-3 describes the specific parameters.

Table 7-3 Fire spot detection description

Parameter	Description	Setting
Enable	At thermal channel, Enable the button to enable the alarm.	[How to set] Click Enable to enable. [Default value] OFF
Output Channel	If you check to set the Output Channel and the device is connected to an external alarm indicator, the alarm indicator signals when an alarm is triggered.	[How to set] Click to select an ID.

Parameter	Description	Setting
Audible alarm	Enable, when an alarm occurs, it will play audio to alarm. Choose the audible alarm file (set at the “ Configuration > Alarm > Audible Alarm Output ”).	[How to set] Click to enable Audible alarm [Default value] OFF
Flashlight alarm	Enable, when it is triggered alarm, it flashes the light. But when users set the display mode to Mode 5 at “ Configuration > Thermal > Led Control Param ”interface, the lighth will be always on for 15s, not flash when it is alarm.	[How to set] Click to enable Flashlight Alarm. [Default value] OFF
Sensitivity	The sensitivity of detecting smoker, when the value is high, the temperature of triggering alarm is lower; When the value is low, the temperature of triggering alarm is higher.	[How to set] Choose from the drop-down list [Default value] 90
SMTP	Enable the button to enable SMTP serve.	[How to set] Click to enable SMTP. [Default value] OFF
FTP Upload	Enable the button to enable File Transfer Protocol.	[How to set] Click to enable FTP Upload. [Default value] OFF
Video Stream Draw Line	Enable the button to enable Video Stream Draw Line, the setting area frame will show on live video.	[How to set] Click to enable Video Stream Draw Line. [Default value] OFF

Step 3 Set a deployment area.

Use mouse to draw rectangular area, you can set several area to deploy, as shown in Figure 7-4.

Figure 7-4 Set deployment area

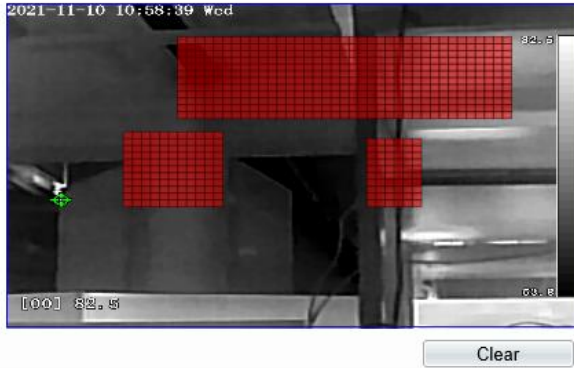
 **NOTE**

- A drawn line cannot cross another one, or the line drawing fails.
- Any shape with 32 sides at most can be drawn.
- The quantity deployment areas is up to 8.

Step 4 Set deployment time.

Step 5 Click **Apply** to save the settings.

---End

8 AI Multi-object

Step 1 At “ Configuration > AI Multiobject ” interface, user can enable full-body detection, vehicle detection to detect the person and vehicle, as shown in Figure 8-1.
Figure 8-1 AI Multiobject

AI Multiobject

Step 2 Set the parameters of AI multiobject following as the Table 8-1 .

Table 8-1 AI multiobject parameters

Parameter	Description	How to set
Channel	Channel 1 is visible channel.	Choose from

	Channel 2 is thermal channel.	drop list.
Full body detection	The camera will snap the whole body when someone appear in live video. The detection frame is blue.	Enable
Vehicle detection	The camera will snap the licence when the vehicle appear in live video. The detection frame is yellow.	Enable
Confidence Coefficient	The range of snap image, there are three type, such as high, mid and low. The higher the confidence, the better the snap quality and the fewer snapshots.	Choose from drop list.
Static Target Filter	If the target is static, the device will filter this target. For example, if a car stop for long time, the device will be filtered.	Enable

Step 3 Draw the detection area by using the mouse.

Step 4 Set the schedule, click “Apply” to save the settings.

---End

9 Alarm Setting

9.1 Alarm Output

Procedure

Step 1 Select **Configuration > Alarm > Alarm Output** to access the **Alarm Output** setting interface, as shown in Figure 9-1.

Figure 9-1 Alarm output interface

Alarm Output	
Alarm Output	1
Name	
Valid Signal	Close
Alarm Output Mode	Switch Mode
Alarm Time(ms)(0:Continuous)	0

Timing Alarm Output OFF

Manual control

Step 2 Set alarm output of channel, name, enable valid signal and alarm time choose alarm output mode.

Step 3 You can also control alarm manually, click **Start** button to start alarm, click stop button to end the alarm .

---End

9.2 Disk Alarm

Procedure

Step 1 Select **Configuration** > **Alarm** > **Disk Alarm** to access the disk alarm setting interface, as shown in Figure 9-2.

Figure 9-2 Disk alarm interface

Disk Alarm

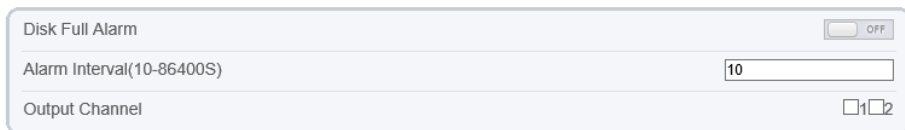

Disk Full Alarm	<input type="checkbox"/> OFF
Alarm Interval(10-86400S)	<input type="text" value="10"/>
Output Channel	<input type="checkbox"/> 1 <input type="checkbox"/> 2

Refresh

Apply

Step 2 Enable the disk full alarm, when the disk is full it will alarm.

Step 3 Set alarm interval and tick output channel.

Step 4 Click **Apply** to save the settings, click refresh will return last settings.

---End

9.3 Network Alarm

Procedure

Step 1 Select **Configuration** > **Alarm** > **Network Alarm** to access the network alarm setting interface, as shown in Figure 9-3.

Figure 9-3 Network alarm interface

Network Alarm

Network Card ID: 1

Exceptional Alarm: ON

Alarm Interval(10-86400S): 10

Output Channel: 1 2

Alarm Record: OFF

Refresh Apply

Step 2 Choose network card ID and enable exceptional alarm to set alarm interval. Tick output channel.

Step 3 Click **Apply** to save the settings, click refresh will return last settings.

---End

9.4 I/O Alarm Linkage

Procedure

Step 1 Select **Configuration > Alarm > I/O Alarm Linkage** to access the **I/O alarm Linkage** setting interface, as shown in Figure 9-4.

Figure 9-4 I/O alarm linkage interface

 I/O Alarm Linkage

Alarm Input

Name

Trigger Mode

Alarm Input ON

Output Channel 1 2

PTZ Linkage OFF

Alarm Record OFF

SMTP OFF

	0	1	2	3	4	5	6	7	8	9	10	11	12	13	14	15	16	17	18	19	20	21	22	23	24
Sun																									
Mon																									
Tues																									
Wed																									
Thur																									
Fri																									
Sat																									

Step 2 Choose alarm input and trigger mode, set name, enable other linkages such as alarm input, PTZ linkage, Alarm Record SMTP, FTP upload, IR Cut and flashlight alarm.

Step 3 Set alarm schedule, choose the duration of linkage.

Step 4 Click **Apply** to save the settings, click refresh will return last settings.

---End

9.5 Motion Alarm

Procedure

Step 1 Select **Configuration > Alarm > Motion Alarm** to access the **Motion Alarm** setting interface, as shown in Figure 9-5.

Figure 9-5 Motion alarm interface

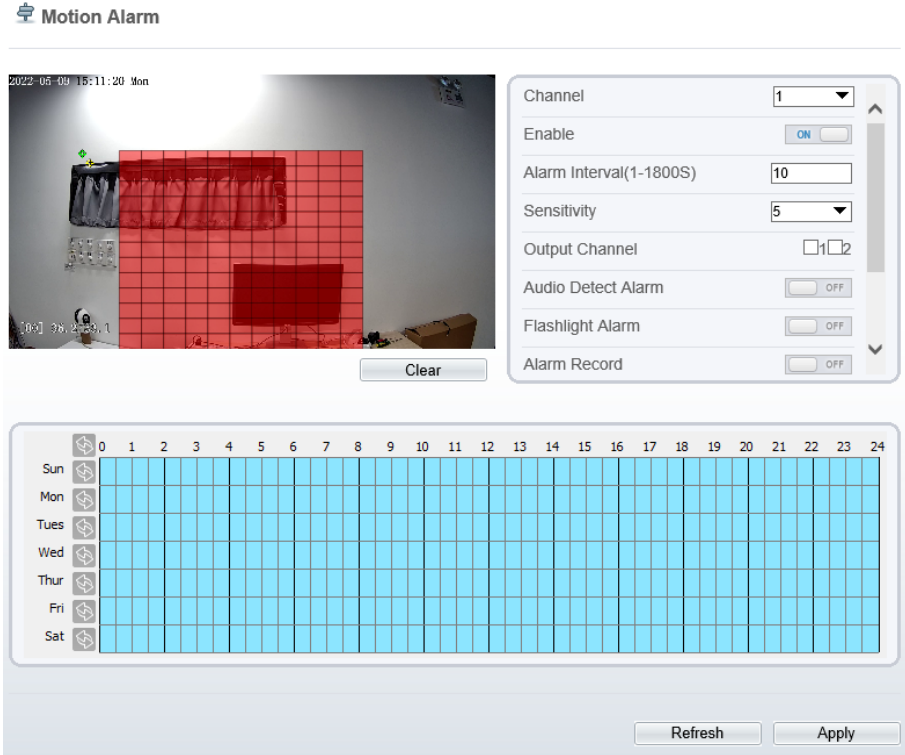

Step 2 Choose channel and enable the motion alarm, set alarm interval and sensitivity, enable other linkages such as SMTP, FTP upload and motion detect stream.

Step 3 Set motion alarm schedule,

Step 4 Click **Apply** to save the settings, click **Refresh** will return last settings.

---End

9.6 Push Message

Procedure

Step 1 Select **Configuration > Alarm > Push Message** to access the **Push Message** setting interface, as shown in Figure 9-6.

Figure 9-6 Push message interface

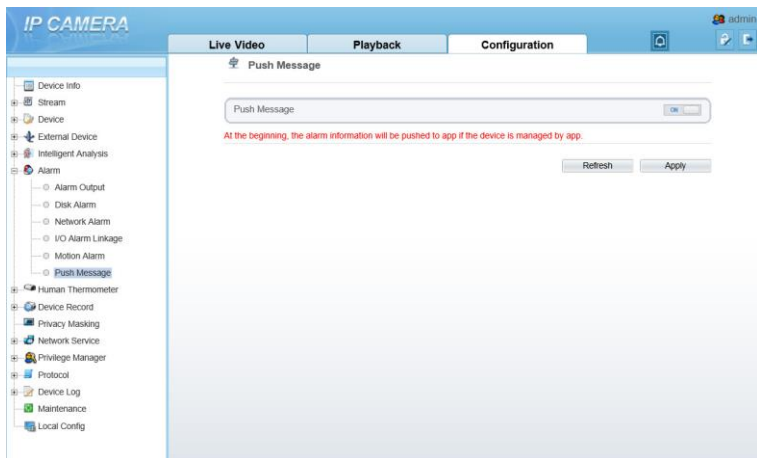

Step 2 Enable the push message, you will receive the message when the alarm happened.

Step 3 Click **Apply** to save the settings, click **Refresh** will return last settings.

---End

9.7 Audio Abnormal Output

Procedure

Step 1 Select **Configuration > alarm > Audio Abnormal Output** to access the **Audio Alarm Output** setting interface, as shown in Figure 9-7.

Figure 9-7 Audio abnormal output interface

 **Abnormal Sound Detection**

Enable	<input checked="" type="checkbox"/> ON
Sudden Rise	<input type="checkbox"/> OFF
Sudden Drop	<input type="checkbox"/> OFF
Output Channel	<input type="checkbox"/> 1
Alarm Record	<input type="checkbox"/> OFF
SMTP	<input type="checkbox"/> OFF
FTP Upload	<input type="checkbox"/> OFF

Armed UnArmed

	0	1	2	3	4	5	6	7	8	9	10	11	12	13	14	15	16	17	18	19	20	21	22	23	24
Sun																									
Mon																									
Tue																									
Wed																									
Thur																									
Fri																									
Sat																									

- Step 2 Enable the audio abnormal detection, enable sudden rise, sudden drop, when happen the condition of enable, it will alarm.
- Step 3 Tick the output channel, enable alarm record, SMTP, FTP upload.
- Step 4 Set alarm schedule, choose the duration of linkage.
- Step 5 Click **Apply** to save the settings, click **Refresh** will return last settings.

---End

10 Other Web Configurations

10.1 Device Information

You can view the information about device, as shown in Figure 10-1.

Figure 10-1 Device information interface

 **Device Info**

Device ID	125DF5
Device Name	<input type="text"/> 
MAC Address	00:1C:27:12:5D:F5

Camera Type	Thermal Device
Product Model	SN-TPC2552DT-23
Manufacturer Name	IPCamera

Hardware Version	V170062_1
Firmware Version	v3.6.0840.1004.3.0.5.3.0
Uboot Version	v6.2_20201113
Kernel Version	v6.1_20201113

Channel Quantity	2
Alarm Input Quantity	2
Alarm Output Quantity	2
Serial Port Quantity	1
Network Card Quantity	1

10.2 Stream

10.2.1 Base Stream

Step 1 Choose **Configuration > Stream > Base Stream**, as shown in Figure 10-2.

Figure 10-2 Base stream interface

 Stream

Channel	1
Stream ID	1
Name	stream1
Video Encode Type	H265
Video Encode Level	Mid
Audio Encode Type	G711_ALAW
Resolution	1920x1080
Frame Rate(fps)	30
I Frame Interval(Unit: Frame)	60
Bit Rate Type	CBR
Bit Rate(kbps)(500-12000)	4096
Smart Encode	<input type="checkbox"/> OFF

Figure 10-3 Channel 2 (thermal channel) stream

Stream

Channel	2
Stream ID	1
Name	stream1
Video Encode Type	H265
Video Encode Level	Mid
Audio Encode Type	G711_ALAW
Resolution	D1
Frame Rate(fps)	25
I Frame Interval(Unit: Frame)	50
Bit Rate Type	CBR
Bit Rate(kbps)(100-6000)	2000
Smart Encode	<input type="checkbox"/> OFF

Refresh Apply

Step 2 Choose channel, stream ID, video encode type, video encode level, audio encode type, resolution, frame rate, frame interval, bit rate type and bit rate from all drop list.

Step 3 Set name of base stream, enable smart encode.

Step 4 Click **Apply**. The message "**Apply success**" is displayed, the system saves the settings.

---End

10.2.2 ROI

Step 1 Choose **Configuration > Stream > ROI**, as shown in Figure 10-4.

Figure 10-4 ROI interface

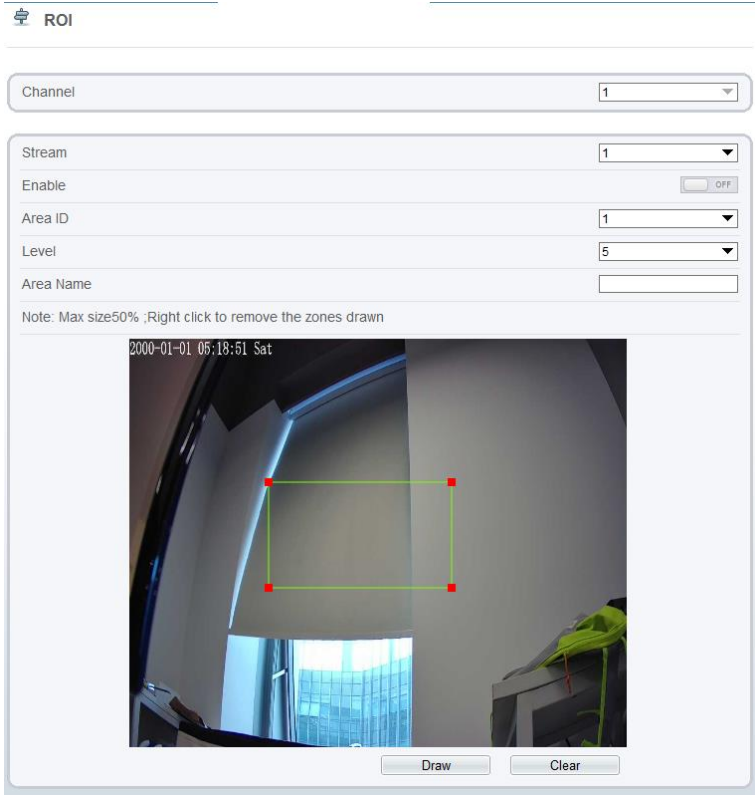

Step 2 Click **Draw** and the frame is showing, adjust the position of frame to set ROI area.

Step 3 Click **Apply**. The message "**Apply success**" is displayed, the system saves the settings.

---End

10.2.3 Snapshot

Step 1 Choose **Configuration > Stream > Snapshot**, as shown in Figure 10-5.

Figure 10-5 Snapshot interface

The screenshot shows the 'Snapshot' configuration page. It features two dropdown menus: 'Snapshot Resolution' set to '1280x720' and 'Snapshot Quality' set to 'Mid'. Below the dropdowns are two buttons: 'Refresh' and 'Apply'.

Step 2 Choose snapshot resolution and snapshot quality from drop list.

Step 3 Click **Apply**. The message "Apply success" is displayed, the system saves the settings.

---End

10.3 Device

You can set local network, device port, data and time, camera, OSD, microphone, CVBS, system, voice denoise and software licenses, as shown in Figure 10-6.

Figure 10-6 Device-local network interface

The screenshot shows the 'IP CAMERA' web interface with the 'Configuration' tab selected. The 'Local Network' section is active, displaying the following settings:

- Network Card ID: 1
- IP Protocol: IPv4
- DHCP: [checked]
- DHCP IP: 192.168.0.121
- Preferred DNS Server: 192.168.32.254
- Alternate DNS Server: [empty]
- MTU(1280-1500): 1500

Buttons for 'Refresh' and 'Apply' are located at the bottom of the configuration area. A sidebar on the left lists various device settings, including 'Local Network', 'External Device', 'Intelligent Analysis', 'Alarm', 'Thermal', 'AI Multiobject', 'Device Record', 'Privacy Masking', 'Network Service', 'Privilege Manager', 'Protocol', 'Device Log', 'Maintenance', and 'Local Config'.

10.4 External Device

The camera is connected PTZ external device, you can choose **Configuration > External Device**, enable PTZ, set parameters as shown in Figure 10-7.

Figure 10-7 External device interface

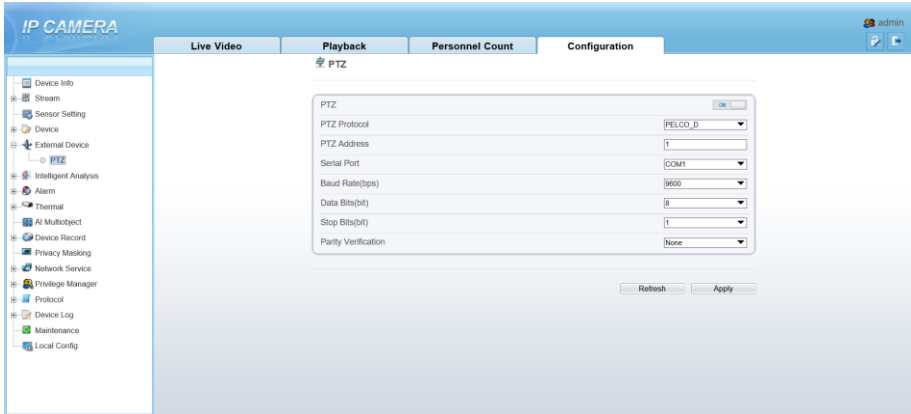

10.5 Privacy Masking

Choose **Configuration > Privacy masking**. You can set privacy masking if some area needs keep secret, drag mouse to select the area to cover, double click will delete the setting, as shown in Figure 10-8.

Figure 10-8 Privacy masking interface

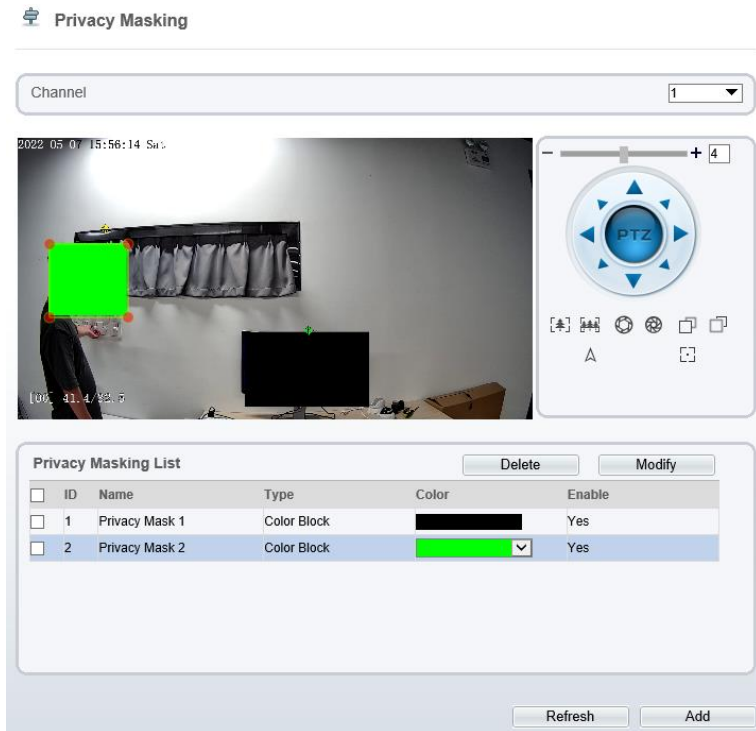

10.6 Network Service

Choose **Configuration > Network Service**. You can set **802.1x, DDNS, PPPoE, Port mapping, SMTP, IP filter, CGI alarm service center, SNMP and QOS**.

10.6.1 QOS

Description

If the device is connected to a router or switch with a QOS function, and the priority rule of the corresponding mark is configured on the network device, the network device will preferentially pass the data packet of the corresponding mark.

Procedure

Step 1 Choose **Configuration > Network Service > QOS**.

The **QOS** page is displayed, as shown in Figure 10-9.

Figure 10-9 QOS page

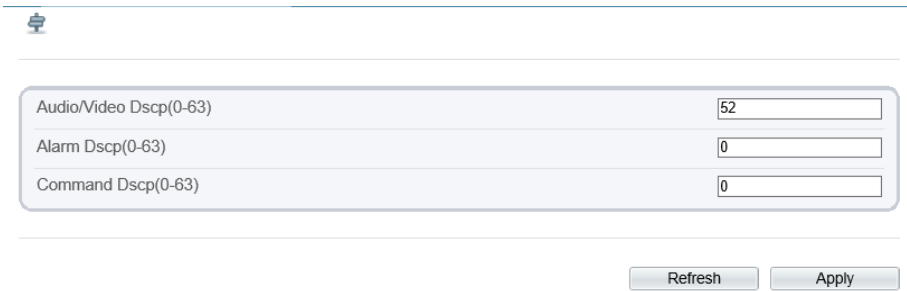

Step 2 Input the value range from 0 to 63 (audio/video dscp, alarm dscp and command dscp).

Step 3 Click **Apply**.

The message "Apply success!" is displayed, and the system saves the settings.

----**End**

10.7 Privacy Manager

Add user account, manage the users' permission. As shown in Figure 10-10.

Figure 10-10 Privacy manager interface

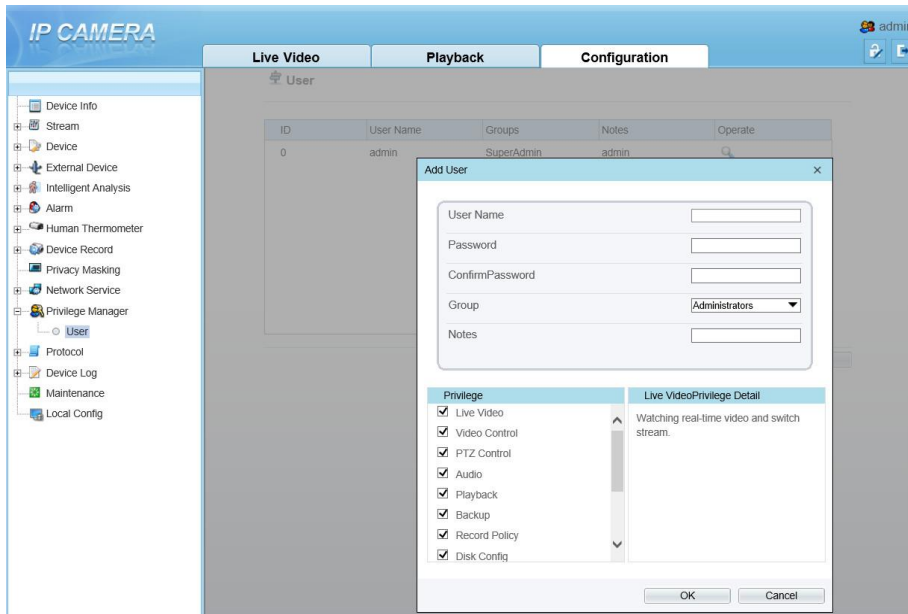

10.8 Protocol

Choose **Configuration > Protocol**. You can set **protocol information, security, CMS configuration and multicast parameter**.

Figure 10-11 Protocol interface

Protocol Info

Protocol Name	ONVIF
Protocol Version	v17.06
Protocol Software Version	v17.06_build000360
RTSP Rule	rtsp://ip.port/snl/live/cameraid/streamid
RTSP Example	rtsp://192.168.0.121:554/snl/live/1/1
Onvif UUID	f5bc7680-bff8-11d3-844f-

10.9 Device Log

Choose **Configuration > Device Log**. You can view **operation log** and **alarm log**, or collect all log information, as shown in Figure 10-12.

Figure 10-12 Device log interface

The screenshot shows the 'IP CAMERA' web interface with the 'Configuration' tab selected. Under 'Configuration', the 'Operation Log' sub-tab is active. The 'Operation Log' section includes a dropdown menu set to 'All Type', 'Begin Time' (2022-05-06 15:59:15), and 'End Time' (2022-05-07 15:59:15). Below this is a table of log entries:

Time	User Name	Log Info
2022-05-07 15:58:50	admin	Stop video
2022-05-07 15:58:50	admin	Stop IntelligenceAnalyse Stream
2022-05-07 15:58:09	admin	Configure bind area
2022-05-07 15:58:06	admin	Configure bind area
2022-05-07 15:58:03	admin	Configure bind area
2022-05-07 15:58:00	admin	Configure bind area
2022-05-07 15:55:58	admin	Configure bind area
2022-05-07 15:55:56	admin	Configure bind area
2022-05-07 15:55:54	admin	Configure bind area
2022-05-07 15:55:53	admin	Start IntelligenceAnalyse Stream

10.10 Maintenance

Choose **configuration > maintenance**. You can **restart**, **update**, **reserve IP setting** and **restore to factory default**, as shown in Figure 10-13.

Figure 10-13 Maintenance interface

Camera Maintenance

- Restart ✳
- Auto Reboot OFF ✓
- Update Please select upgrade file Update
- Reserve IP setting ON
- Restore To Factory Default ↺
- Export configuration Download
- Import configuration Please choose file Upload

10.11 Local Config

When users choose IPC Local Server to play live video, this function can be set.

Choose **Configuration > Local Config**. You can change the save path of snapshot and local record, choose the playback performance, as shown in Figure 10-14.

Figure 10-14 Local config interface

Local Config

- SnapShot Save Path 📁
- Local Record Save Path 📁
- Playback performance ▼

11 A Troubleshooting

Common Trouble	Possible Cause	Solution
Unable to access the web	Network is not connected.	Connect the network cable of the camera to the PC to check whether the network cable is in good contact. Run the ping command to check the network connection and whether the device works normally.
	IP address is occupied.	Directly connect the camera to the PC, and reset the IP address of the camera.
	The IP addresses of the PC and the device are in different networks.	Check the IP address, subnet mask and gateway setting of the camera.
The measured temperature is not accurate.	The device is just powered on, and the temperature of the cavity is unstable.	The temperature of the cavity is stable within 15 to 30 minutes after the device is powered on.
	The target configuration is incorrect.	Check whether the emission rate and distance of the target are configured correctly.
An error occurs in accessing the web of the device after the upgrade.	The data in the cache of browser is not updated in time.	Delete the cache of browser. The steps are as follows (taking Edge as an example): Open the Edge. Press Ctrl + Shift + Delete on keyboard. The Delete Browsing History dialog box appears. Select all check boxes. Click Clear to delete. Relogin the web page of the camera.
Upgrade failed.	No network cable is connected. The network setting is incorrect.	Ensure the upgrade network is connected. Check whether the network setting is correct.

Common Trouble	Possible Cause	Solution
	The upgrade package is incorrect.	Perform the correct upgrade package again.
The temperature is too high.	<ol style="list-style-type: none">1. Make sure 'thermal mapping' and 'thermal calibration is configured correctly' by checking highest temperature object at two channels.2. Check if the temperature data is inconsistent with the actual temperature, the temperature may be too high.	