

# Thermal Imaging Network Bullet Camera User Manual



**Issue**

**V1.2**

**Date**

**2023-03-30**








# Precautions

## Precautions

Fully understand this document before using this device, and strictly observe rules in this document when using this device. If you install this device in public places, provide the tip "You have entered the area of electronic surveillance" in an eye-catching place. Failure to correctly use electrical products may cause fire and severe injuries. To prevent accidents, carefully read the following context:

## Symbols

This document may contain the following symbols whose meanings are described accordingly.

Symbol	Description
 <b>DANGER</b>	It alerts you to fatal dangers which, if not avoided, may cause deaths or severe injuries.
 <b>WARNING</b>	It alerts you to moderate dangers which, if not avoided, may cause minor or moderate injuries.
 <b>CAUTION</b>	It alerts you to risks. Neglect of these risks may cause device damage, data loss, device performance deterioration, or unpredictable results.
 <b>TIP</b>	It provides a tip that may help you resolve problems or save time.
 <b>NOTE</b>	It provides additional information.

### **DANGER**

To prevent electric shocks or other dangers, keep power plugs dry and clean.

### **WARNING**

- Strictly observe installation requirements when installing the device. The manufacturer shall not be held responsible for device damage caused by users' non-conformance to these requirements.

- Strictly conform to local electrical safety standards and use power adapters which are marked with the LPS standard when installing and using this device. Otherwise, this device may be damaged.
- Use accessories delivered with this device. The voltage must meet input voltage requirements for this device.
- If this device is installed in places with unsteady voltage, ground the device to discharge high energy such as electrical surges in order to prevent the power supply from burning out.
- When this device is in use, ensure that no water or any liquid flows into the device. If water or liquid unexpectedly flows into the device, immediately power off the device and disconnect all cables (such as power cables and network cables) from this device.
- Do not place the thermal imaging camera and unpackaged products at a radiation source with a high intensity regardless of whether the device is in the normal power-on state, for example, the sun, laser, and electric arc welder, and place the thermal imaging camera and unpackaged products against objects with a high heat source, for example, the sun. Otherwise, the accuracy of the thermal imaging camera will be affected. In addition, the detector in the thermal imaging camera may be permanently damaged.
- If this device is installed in places where thunder and lightning frequently occur, ground the device nearby to discharge high energy such as thunder strikes in order to prevent device damage.



### CAUTION

- Unless otherwise specified in the user manual, do not use the thermal imaging camera in an environment with the temperature lower than  $-40^{\circ}\text{C}$  ( $-40^{\circ}\text{F}$ ) or higher than  $60^{\circ}\text{C}$  ( $+140^{\circ}\text{F}$ ). Otherwise, the images displayed by the thermal imaging camera are abnormal and the device may be damaged because of working beyond the temperature range for a long period.
- As for the outdoor installation, avoid the morning or evening sunlight incidence to the lens of the thermal imaging camera. The sun shade must be installed and adjusted according to the angle of the sunlight illumination.
- During transportation and storage, avoid damage to products caused by heavy pressure, severe vibration and soaking. The warranty does not cover any device damage that is caused during secondary packaging and transportation after the original packaging is taken apart.
- This device is sensitive to static. Improper static may damage the thermal imaging camera. ESD protection measures and reliable grounding must be well prepared for device installation and uninstallation.
- Protect this device from fall-down and intensive strikes, keep the device away from magnetic field interference, and do not install the device in places with shaking surfaces or under shocks.
- Clean the device body with a soft and dry cloth. In case that the dirt is hard to remove, use a dry cloth dipped in a small amount of mild detergent and gently wipe the device,

and then dry it again. Pay special attention to the front window of the thermal imaging camera because this is precision optics. If the front window has water spots, use a clean and soft cloth moistened with water and wipe it. If the front window needs further cleaning, use a soft cloth dampened with isopropyl alcohol or detergent. Improper cleaning can cause damage to the device.

- The lens window of the thermal imaging camera is designed to be applicable to an outdoor environment. The window is coated with durable coating material, but may require frequent cleaning. When you found lens image degradation or excessive accumulation of pollutants, you should clear up the window in a timely manner. Exercise caution when you use this device in severe sandstorm (such as deserts) or corrosive environments (such as offshore). Improper use may cause surface coating off.
- Do not jam the ventilation opening. Follow the installation instructions provided in this document when installing the device.
- Keep the device away from heat sources such as radiators, electric heaters, or other heat equipment.
- Keep the device away from moist, dusty, extremely hot or cold places, or places with strong electric radiation.
- If the device is installed outdoors, take insect- and moisture-proof measures to avoid circuit board corrosion that can affect monitoring.
- Remove the power plug if the device is idle for a long time.
- Before unpacking, check whether the fragile sticker is damaged. If the fragile sticker is damaged, contact customer services or sales personnel. The manufacturer shall not be held responsible for any artificial damage of the fragile sticker.

## Special Announcement

All complete products sold by the manufacturer are delivered along with nameplates, operation instructions, and accessories after strict inspection. We shall not be responsible for counterfeit products.

The manual may contain inaccurate information of function and operation, misprints. The manufacturer will update this manual according to product function enhancement or changes and regularly update the software and hardware described in this manual. Updated information will be added to new versions of this manual without prior notice.

Pictures for reference only, subject to our available products.

# Contents

<b>Precautions</b> .....	<b>i</b>
<b>Contents</b> .....	<b>iv</b>
<b>1 Product Overview</b> .....	<b>6</b>
1.1 Thermal Imaging Principles and Advantages .....	6
1.2 Device Structure .....	6
1.3 Out Wire Connection .....	8
1.3.1 The Multi-connector Cable .....	8
1.3.2 Integrated Cable Management Bracket .....	10
1.4 Functions and Features .....	11
1.5 Packing List .....	12
1.6 Device Dimensions .....	12
1.7 Installation .....	20
1.7.1 Preparations .....	20
1.7.2 Installation Mode .....	20
1.7.3 Installing A Bracket .....	21
1.7.4 Installing B Bracket With Junction Box .....	25
1.7.5 Installing C Bracket Without Junction Box .....	28
<b>2 Quick Configuration</b> .....	<b>31</b>
2.1 Login and Logout .....	31
2.2 Browsing Video .....	32
2.2.2 Install Plugins .....	34
2.3 Main Page Layout .....	35
2.4 Changing the Password .....	37
2.5 Setting Local Network Parameters .....	38
<b>3 Thermal Settings</b> .....	<b>42</b>
3.1 Temperature Parameters .....	42
3.2 Ambient Temperature .....	47
3.3 Temperature Alarm .....	48
3.4 Privacy Zone Masking .....	53
3.5 Schedule Linkage .....	54
3.6 Defect Pixel Correction .....	62
<b>4 Image Settings</b> .....	<b>64</b>
4.1 Image Settings Interface .....	64

---

4.2 Mode .....	65
4.3 Images .....	66
4.4 Scene .....	67
4.5 Set Pseudocolor .....	69
4.6 FFC Control .....	70
4.7 Noise Reduction .....	72
<b>5 Intelligent Analysis .....</b>	<b>74</b>
5.1 Intrusion .....	74
5.2 Single Line Crossing .....	77
5.3 Double Line Crossing .....	80
5.4 Object Left .....	83
5.5 Object Removed .....	86
5.6 Advanced .....	88
<b>6 A Troubleshooting .....</b>	<b>91</b>
<b>B Common Emission Rate .....</b>	<b>93</b>

# 1 Product Overview

---

## 1.1 Thermal Imaging Principles and Advantages

For any object, as long as its temperature is above the absolute zero ( $-273.15^{\circ}\text{C}$ ), although the object does not give out light, it can radiate infrared. The infrared is also known as thermal radiation. A temperature change occurs when the infrared radiated by objects at different temperatures is absorbed by the infrared thermal detector, and thereby generating an electrical effect. An electrical signal is amplified and processed to obtain a thermal image corresponding to the distribution of heat on the surface of the object, that is, infrared thermal imaging.

### **Applicable to any light environment**

Traditional cameras rely on the natural or ambient light for imaging. However, the infrared thermal imaging camera can clearly image the object with the infrared heat radiation of the object without relying on any light. The infrared thermal camera is applicable to any light environment and is free from glare impact. It can clearly detect and find the target as well as identify the camouflaged and hidden target in both day and night. Therefore, it achieves real 24-hour surveillance.

### **Monitoring the temperature field of the target heat distribution**

The infrared thermal camera can display the temperature field of the object and change the surface temperature distribution of the object that cannot be directly seen by human eyes to the thermal image representing the surface temperature distribution of the object. By monitoring the temperature field, you can immediately identify the temperature abnormality, thereby preventing potential risks caused by the temperature, such as fire.

### **Providing the cloud penetration capability**

Atmosphere, dust, and clouds can absorb visible light and near-infrared, but are clear to the thermal infrared for 3 to 5 microns (medium wave infrared region) and 8 to 14 microns (long wave infrared). Therefore, it is difficult for the conventional cameras to capture clear images under dense clouds, while the thermal imaging camera is able to effectively penetrate the atmosphere and clouds to capture clear images.

## 1.2 Device Structure

Figure 1-1 shows the rear panel of the Thermal Imaging Network Bullet Camera. For details about the interfaces, see Table 1-1.



Figure 1-1 Appearance and interfaces of the Thermal Imaging Network Bullet Camera

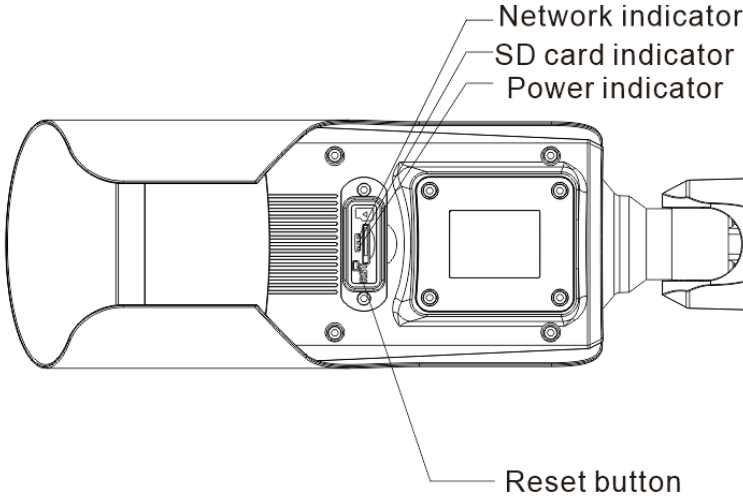


Table 1-1 Parameters of Interfaces

No.	Physical Interface	Connection
1	Network indicator	The network is working normally, the light is on; When it is transferring data, the light is splash.
2	SD card indicator	The SD indicator has the following states: OFF: The SD card is not inserted. ON: The SD card is inserted.
3	Power indicator	The power supply is plugged and works normally, the red light is on.
4	Reset button (RESET)	The configuration resumes to the factory settings after you press the reset button for 5s. The default value is 192.168.0.121.
5	SD card slot	It places the SD card. Note: <ul style="list-style-type: none"> <li>When you install the SD card, ensure that the SD card is not in the write-protection state and then insert the SD card in the SD card slot.</li> <li>When you remove the SD card, ensure that the SD card is not in the write-protection state. Otherwise, the data may be lost or the SD card may be damaged.</li> <li>When hot plugging the SD card, stop recording and then perform the</li> </ul>

No.	Physical Interface	Connection
		corresponding operation.

## 1.3 Out Wire Connection

There are two ways to connect the Thermal Imaging Network Bullet Camera, the multi-connector cables and the integrated cable management bracket. Users can choose the corresponding method and installation method according to their bracket.

### 1.3.1 The Multi-connector Cable

Figure 1-2 the multi-connector cable of the Thermal Imaging Network Bullet Camera. For details of the multi-connector combination cable, please refer to Table 1-2.

Figure 1-2 Multi-connector combination cable

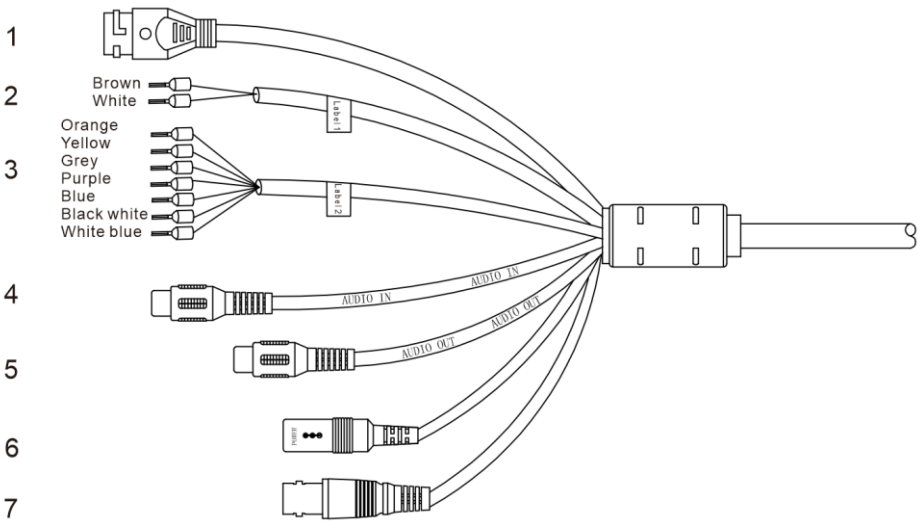


Table 1-2 Multi-connector Combination Cable

ID	Core of Cable	Functions	Connection
1		Network interface	Connects to the standard Ethernet cable.
2	Brown	RS485RS+	RS485 interface, connect to the pan & tilt.
	White	RS485RS-	
3	Orange	Alarm out com 1	Connect to the alarm output /input device.
	Yellow	Alarm out 1	
	Gray	Alarm in com	
	Purple	Alarm in 1	
	Blue	Alarm in 2	
	White/black	Alarm out com 2	
	White / blue	Alarm out 2	
4	-	Audio input port (cable input)	Inputs the audio signal and receives the analog audio signals from the sound pick-up device.
5	-	Audio output	Connects to the external audio device such as the voice box.
6	-	DC12V /AC 24V	Power interface, connects to the 12 V DC (AC 24V) power supply.
7	-	BNC port	CVBS, output analog video signal, connect to screen.

## 1.3.2 Integrated Cable Management Bracket

Figure 1-3 Integrated Cable Management Bracket Port

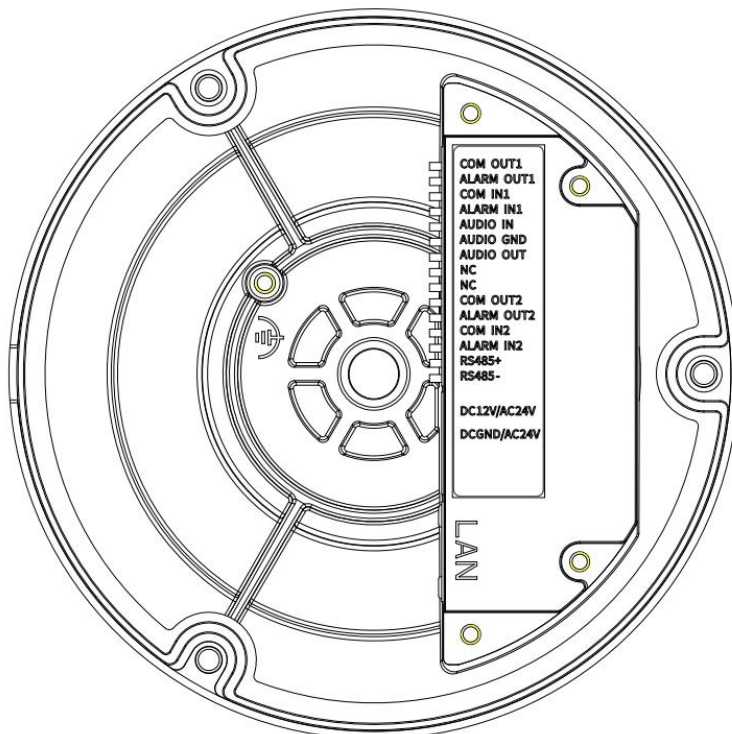


Table 1-3 Integrated Cable Management Bracket Port

Port Name	Description	Remark
COM OUT 1	Alarm out com 1	
ALARM OUT1	Alarm out 1	
COM IN 1	Alarm in 1 com	
ALARM IN1	Alarm in 1	
AUDIO IN	input port (cable input)	Applied for audio devices.
AUDIO GND	Audio port GND	
AUDIO OUT	Audio output	
COM OUT2	Alarm out com 2	

ALARM OUT2	Alarm out 2	
COM IN2	Alarm OUT com 2	
ALARM IN2	Alarm in 2	
RS485+	RS485+	Applied for connecting to external PTZ
RS485-	RS485-	
DC IN/AC24	DC 12 V +	Support AC 24V
DC GND/AC24	DC 12V -	
LAN	Network port, connect to internet. Support PoE supply.	

## 1.4 Functions and Features

- Using the uncooled infrared focal plane sensor
- Detecting the infrared wavelength ranging from 8 um to 14 ums
- 400\*300 pixels
- High thermal sensitivity, reaching 50 mKs
- Supporting dedicated lens for 8/15/25/35/50 mm focal distance (optional)
- Supporting 17 pseudo color modes such as black hot, white hot, rainbow, iron bow and so on
- Supporting the DVE image enhancement
- Supporting noise reduction and mirroring
- Supporting three coding algorithms, that is H.265, H.264 and MJPEG, it is high compatibility
- In the heat setting temperature measuring points in the image or temperature area, temperature detection and display: point temperature measurement, regional temperature measuring, full screen, temperature measurement.
- Over temperature warning and over temperature alarm
- Outputting three code streams in real time, and satisfying local storage and network transmission of the video
- 1-channel audio input and 1-channel audio output, supporting bidirectional voice talkback
- Supporting the local storage of the Micro SD card (the maximum capacity is 128 GB) and effectively resolving the video loss problem caused by network failure
- Providing software and hardware watchdogs and automatic fault recovery

- Linked heat dissipation structure of the metal enclosure
- 3-axis rotational adjustment structure facilitating installation and adjustment
- DC 12 V(2A) / AC24V/ PoE

## 1.5 Packing List

Unpack and check the appearance of product for no obvious damage, and confirm the item list for Table 1-4 is consistent.

Table 1-4 Packing List

Item	Quantity	Remark
Thermal camera	1	
User manual	1	
Installation location label	1	
Network interface protect cover	1	
Plastic anchor	3/4	
Self-tapping screw	3/4	
Allen Key	2	Two types
T15 wrench	1	Configured for B bracket
Plug and sealing ring	2	Configured for B bracket
Grand Head	1	Configured for B bracket
Junction box and accessories	1	Configured for B bracket

## 1.6 Device Dimensions

The different brackets of device are having different dimensions, please refer to actual product.

Figure 1-4 The A Bracket Dimensions (unit: mm)

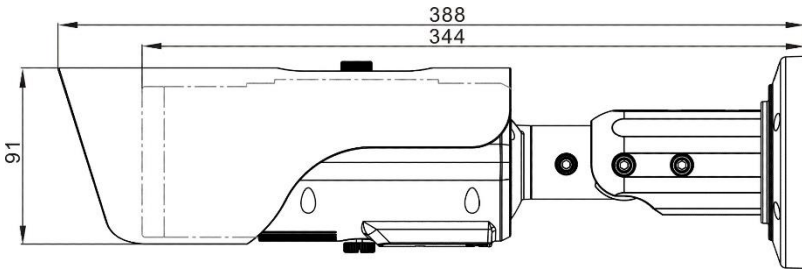
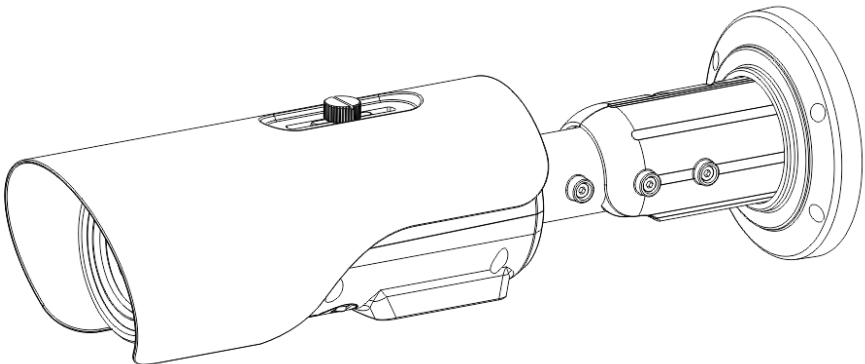
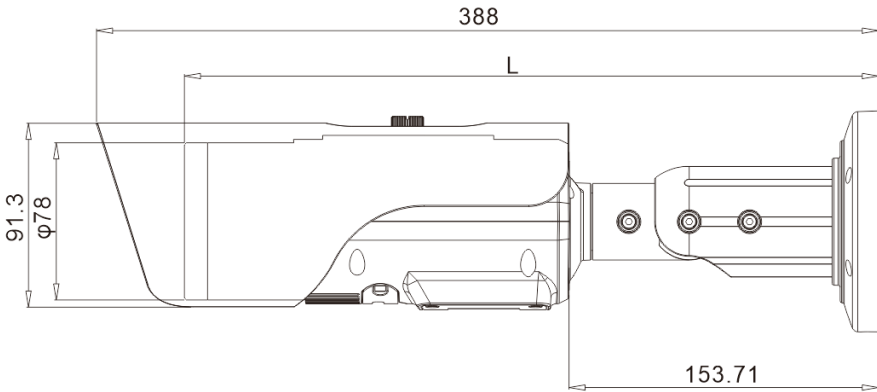


Figure 1-5 The A-1 Bracket Dimensions (unit: mm)





F15/F25 L=348mm  
F35 L=363.4mm  
F50 L=376.4mm

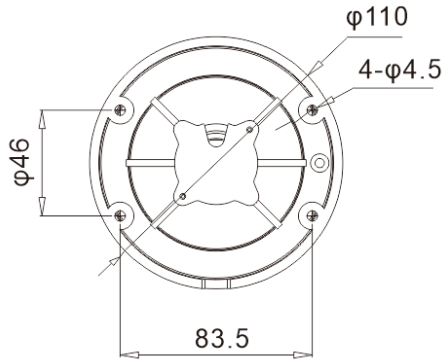




Figure 1-6 The B Bracket With Junction Box Dimensions (unit: mm)

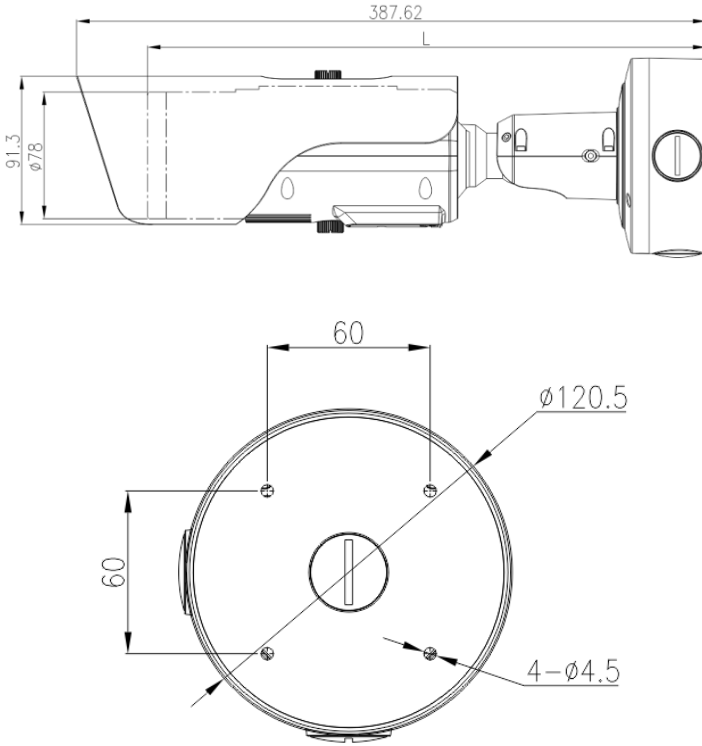
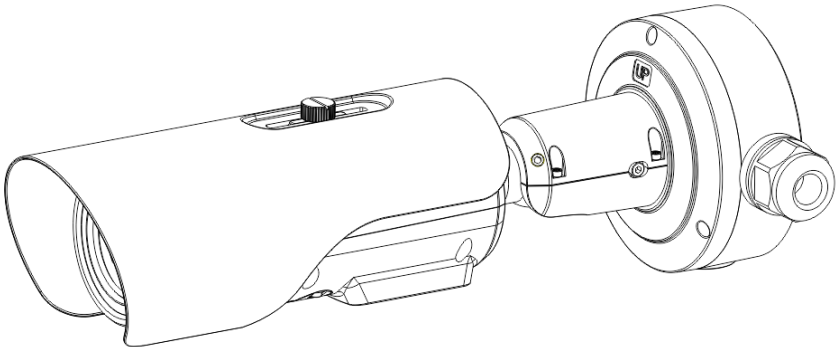
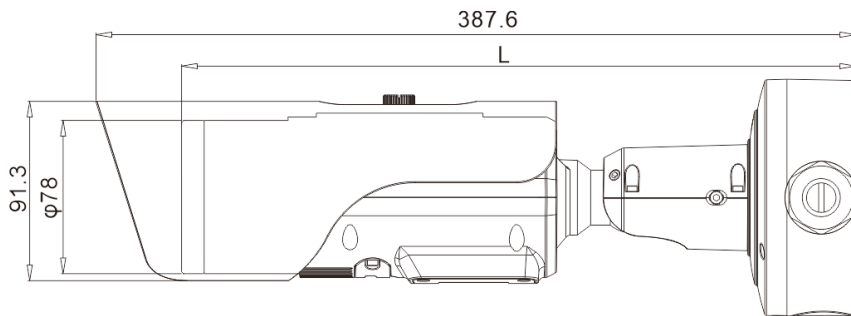


Figure 1-7 The B-1 Bracket with Junction box Dimensions (unit: mm)





F15/F25 L=348mm  
F35 L=363.4mm  
F50 L=376.4mm

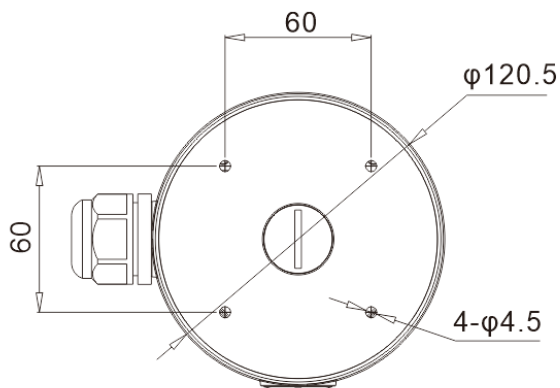
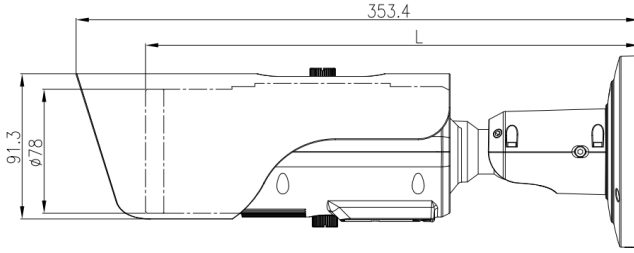


Figure 1-8 The C Bracket Dimensions (unit: mm)



F15/F25 L=313.8mm  
F35 L=329.4mm  
F50 L=341.8mm

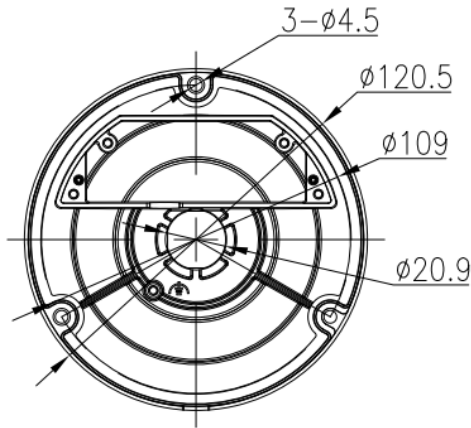
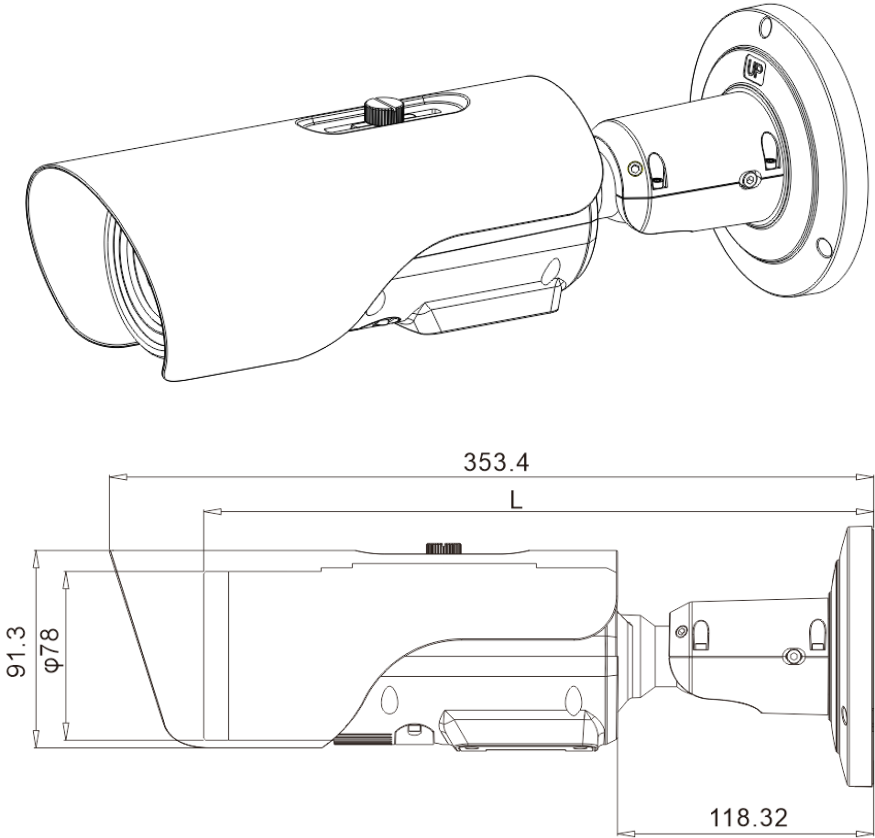
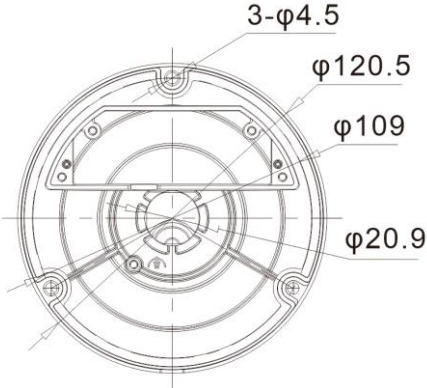


Figure 1-9 The C-1 Bracket Dimensions (unit: mm)



F15/F25 L=313.8mm  
F35 L=329.4mm  
F50 L=341.8mm










## 1.7 Installation

### 1.7.1 Preparations

Tools needed (Not included) and supplied parts are shown in Table 1-5.

Table 1-5 Installation Tools

Tools	Appearance
Phillips screwdriver (Not included)	
Claw hammer (Included)	
Hammer drill (Not included)	
Spirit level (Not included)	
T15 ring spanner (Included)	
Self-tapping screw (Included)	
Inflatable colloidal particle (Included)	

### 1.7.2 Installation Mode

The thermal imaging bullet camera can be installed on the ceiling or the wall. You can select the appropriate installation according to your requirements. If the camera needs to be installed on the cement wall, you need to install the expansion screws (the

mounting holes of the screws must be consistent with that of the support), and then install the support.

### NOTE

The wall where the support is mounted must be able to withstand at least three times of the total weight of the support and the camera.

The different brackets have different installation methods, please choose the correspond method according to the purchased product.

## 1.7.3 Installing A Bracket

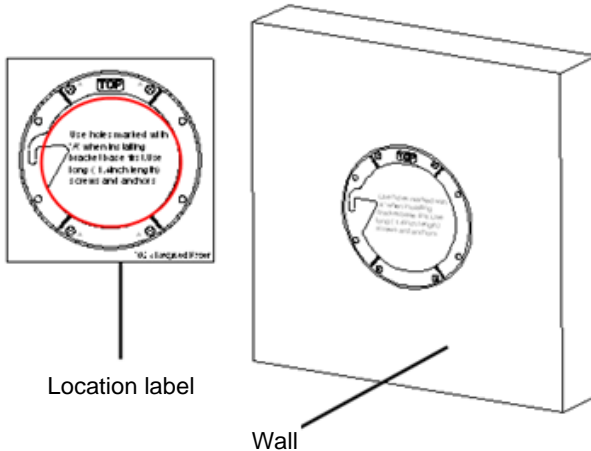
Step 1 Remove the installation location label delivered with the camera. Stick it on the ceiling or the wall, as shown in Figure 1-10.

### NOTE

If you choose the back leading mode, punch a leading-out hole on the ceiling or the wall, as shown in the area highlighted in red in Figure 1-10. (This manual takes the back leading mode as an example.)

If you choose the side leading mode, lead the multi-connector combination cable from the side notch on the bottom of the camera.

Figure 1-10 Installation Location Label



Step 2 According to the location hole positions shown in the installation location label, punch four location holes with diameter 5 mm on the ceiling or the wall.

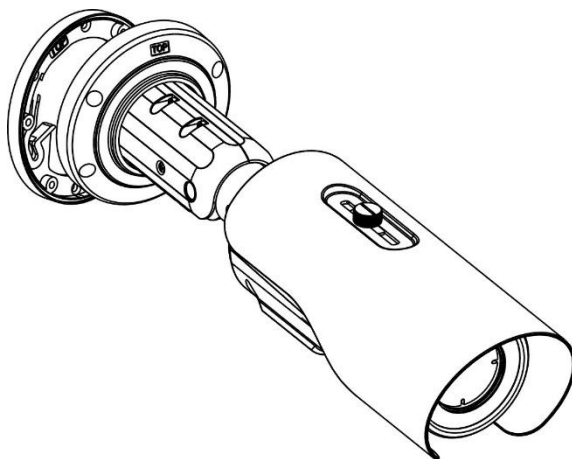
Step 3 Fix the installation base on the wall, as shown in Figure 1-11.

Figure 1-11 Fixing Base



Step 4 Hang the bullet camera into the base along the guide slots and rotate it to a certain angle for facilitate cable connection, as shown in Figure 1-12.

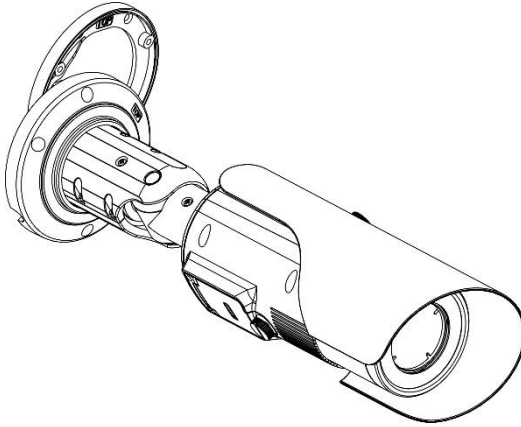
Figure 1-12 Hang the Bullet Camera Into the Base



Step 5 Connect and conceal the cables for the bullet camera. After wiring, rotate the bullet camera to align with the installation base, as shown in Figure 1-13.

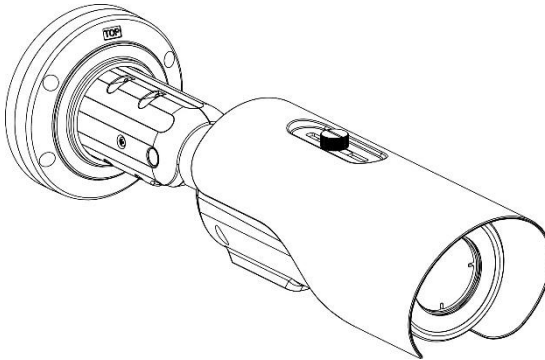


Figure 1-13 Align With the Base



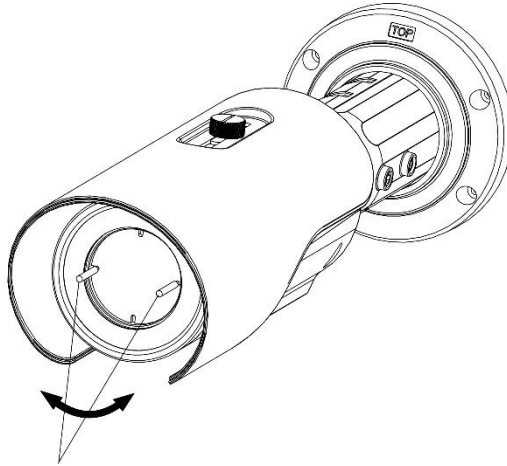
Step 6 Fix the bullet camera to the installation base, as shown in Figure 1-14.

Figure 1-14 Fix the Bullet Camera to the Installation Base



Step 7 Put the screws into the holes and focus by manual as shown in Figure 1-15.

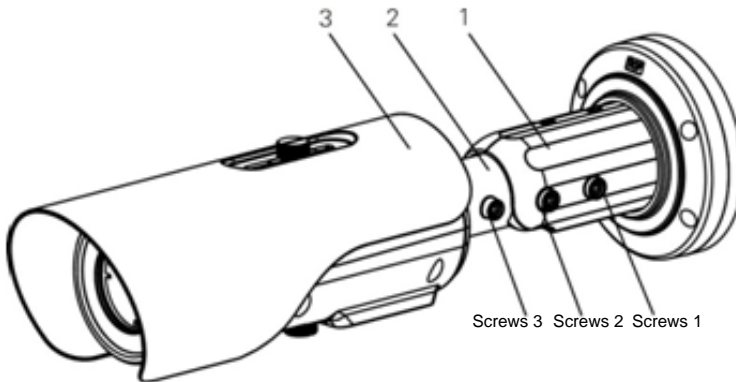
Figure 1-15 Focus With Focusing Screws



Focusing screw x2

Step 8 Adjust the surveillance angle, as shown in Figure 1-16, and then fix the screws.

Figure 1-16 Adjust the Surveillance Angle



1. Loosen the screws 1, and adjust the part 1 along the arrow direction. The adjustment angle is 360 degrees.
1. Loosen the screws 2, and adjust the part 2 along the arrow direction. The adjustment angle is 90 degrees.
1. Loosen the screws 3, and adjust the part 3 along the arrow direction. The adjustment angle is 360 degrees.

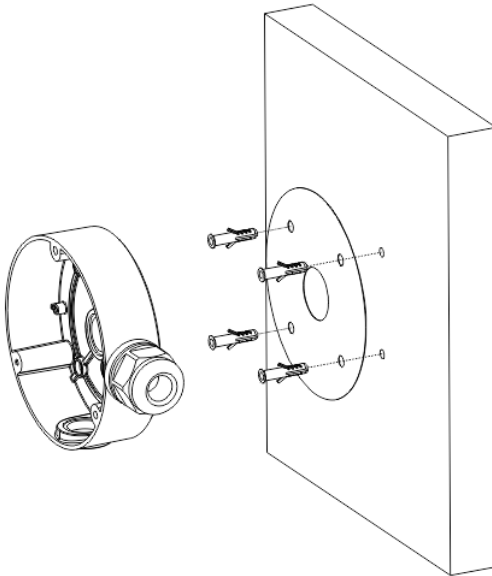
----End

## 1.7.4 Installing B Bracket With Junction Box

Step 1 Take out the installation location label from the package, stick it on the ceiling or the wall. According to the location hole positions shown in the installation location label, punch four location holes on the ceiling or the wall.

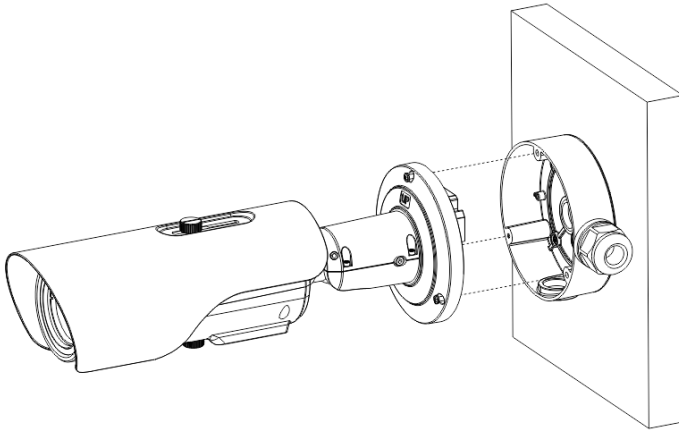
Step 2 Drive the plastic anchors into the holes, fix the junction box by self-tapping screws, as shown in Figure 1-17.

Figure 1-17 Fixing Junction Box



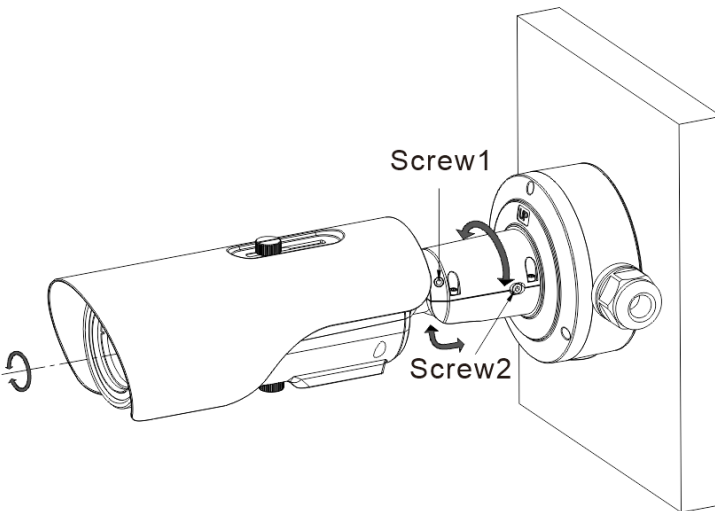
Step 3 Wiring of junction box. Align the holes in bracket with the box and fix the camera to the box with self-tapping screws, as shown in Figure 1-18.

Figure 1-18 Fix the Camera to Junction Box



Step 4 Connect the multi connector cable. Loosen screw 1 and screw 2, adjust the surveillance angle, as shown in Figure 1-19.

Figure 1-19 Adjust the Surveillance Angle



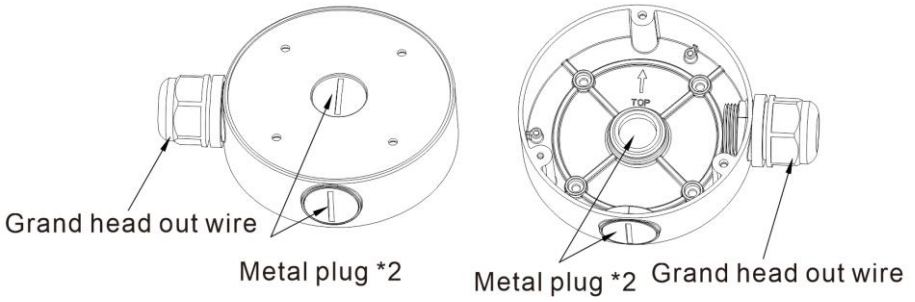
Step 5 As for focusing the lens, please refer to Figure 1-23.

Step 6 After adjusting angle, fix screw 2 and screw 1 in turn to finish installation.

 **NOTE**

There are three pipe thread interface in the junction box, one of which needs to be used with Grand head, so our company provides two plugs.

Figure 1-20 Installing Plug



---End

## 1.7.5 Installing C Bracket Without Junction Box

Step 1 Take out the installation location label from the package, stick it on the ceiling or the wall. According to the location hole positions shown in the installation location label, punch three location holes on the ceiling or the wall.

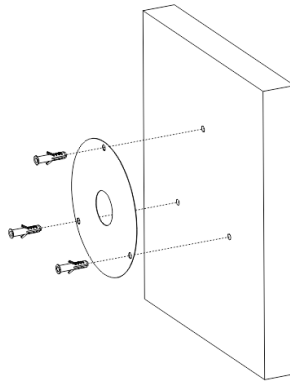
Step 2 Drive the plastic anchors into the holes, as shown in Figure 1-21.

### NOTE

If you choose the back leading mode, drill a leading-out hole on the ceiling or the wall, as shown in the area highlighted in red in Figure 3-1. (This manual uses the back leading mode as an example.)

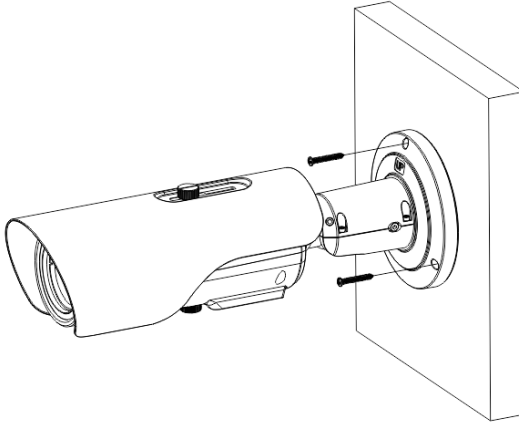
If you choose the side leading mode, lead the multi-connector combination cable from the side notch on the bottom of the camera.

Figure 1-21 Installation Location Label



Step 3 Align the holes in bracket with the plastic anchors in ceiling or wall, fix the bracket with self-tapping screws, as shown in Figure 1-22.

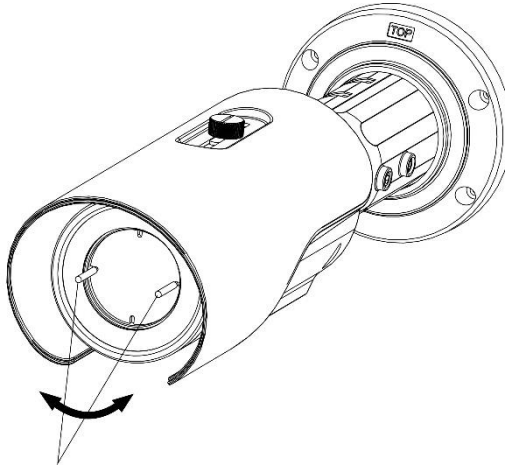
Figure 1-22 Fixing Camera



Step 4 Connect the multi connector cable. Loosen the screw 1 and screw 2, adjust the surveillance angle, as shown in Figure 1-24

Step 5 Insert the focusing screw into the screw hole and focus along the direction of arrows as shown in Figure 1-23.

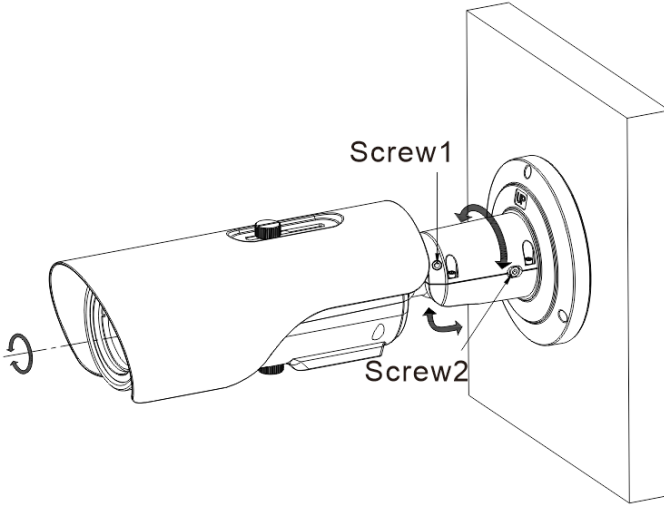
Figure 1-23 Focus With Focusing Screws



Focusing screws x2

Step 6 After adjusting angle, fix screw 2 and screw 1 in turn to finish installation, as shown in Figure 1-24.

Figure 1-24 Adjust the Surveillance Angle



----End



## 2 Quick Configuration

### 2.1 Login and Logout



#### CAUTION

To access the web interface through Microsoft Edge browser (IE Mode); Otherwise, some functions may be unavailable.

#### Login system

Step 1 Open the Microsoft Edge, enter the IP address of IP camera (default value: 192.168.0.121) in the address box, and press Enter. Choose the IE mode.

The login page is displayed, as shown in Figure 2-1.

Figure 2-1 Login Page

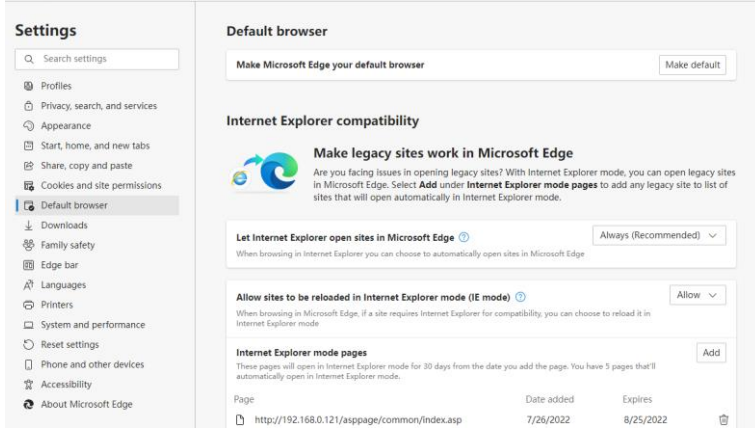
The screenshot shows the login interface for an IP camera. It features a light blue header with the text 'IP CAMERA' in a large, bold, blue font. To the right of the header, there is a language selection dropdown menu currently set to 'English'. Below the header, there are two text input fields: one for 'User Name' and one for 'Password'. To the right of these input fields is a blue button labeled 'Login'.



#### NOTE

Access the web at Edge browser which the mode should switch to **Reload in Internet Explorer mode**. At browser “Setting > Default browser” page, **Let Internet Explorer open sites in Microsoft Edge** choose “Always (Recommended)”; **Allow sites to be reloaded in Internet Explorer mode (IE mode)** choose “Allow”.

Figure 2-2 Internet Explorer Compatibility



- The default name and password are both admin. Modify the password when you login the system for first time to ensure system security.
- After modifying password, you need to wait at least three minutes then power off to make sure modifying successfully. Or login the Web again to test the new password.
- You can change the system display language on the login page.

Step 2 Input the user name and password.

#### NOTE

The default name is **admin**. The default password is **admin**. For system security, please change your password after your first login.


Select the language you need on login page.

Step 3 Click Login.

The main page is displayed.

----End

## Logout

To logout of system, click  in the upper right corner of the main page, the login page is displayed after you log out of the system.

## 2.2 Browsing Video

User can browse the real-time video in the web management system.

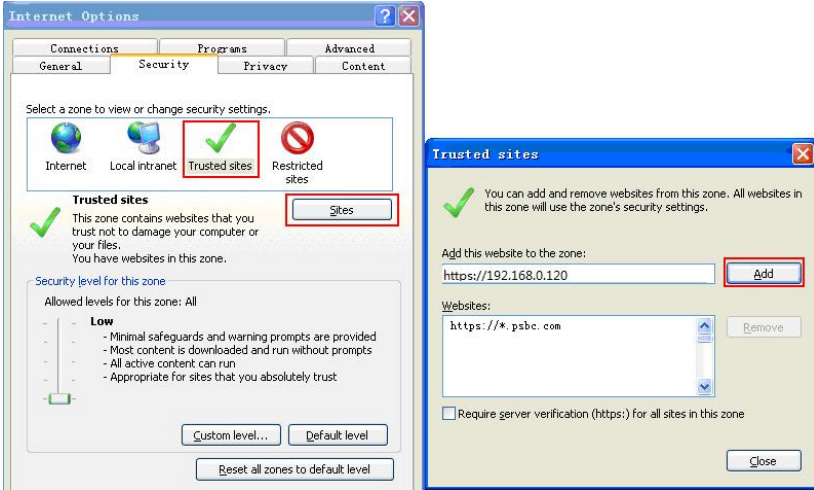
## Preparation

In order to view live video normally, the following steps are performed for the first access.

Step 1 Open the Microsoft Edge. Choose **Control panel > Internet options > Security > Trusted sites > Sites**.

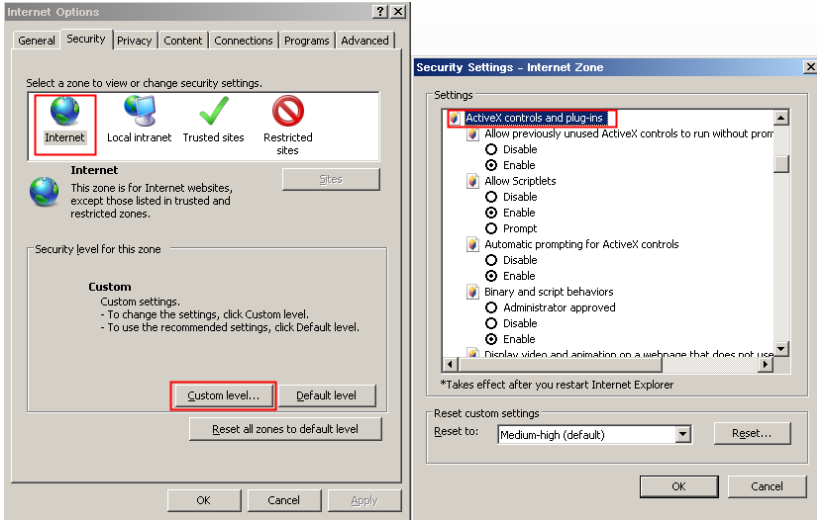
In the display dialog box, click **Add**, as shown in Figure 2-3.

Figure 2-3 Adding a Trusted Site



Step 2 In Microsoft Edge, choose **Control panel > Internet Options > Security > Custom level**, and set “Download unsigned ActiveX control” and “initialize and script ActiveX controls” not marked as safe for scripting under “ActiveX controls and plug-ins” to “Enable”, as shown in Figure 2-4.

Figure 2-4 Configuring ActiveX Control and Plug-ins



Step 3 Download and install the player control as prompted.

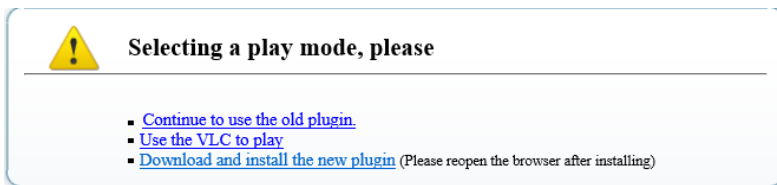
#### NOTE

The login page is displayed when the control is loaded.

## 2.2.2 Install Plugins

You will be prompted with a message “Download and install the new plugin” will show as in Figure 2-5, when you log in to the web management system for the first time.

Figure 2-5 Install Plugin



### Procedure

Step 1 Click the message, download and install the plugin following the prompts.

Step 2 During installing, users should close the browser.

Step 3 Reopen the browser after installation.

Step 4 Input the IP address to login.

----End



## 2.3 Main Page Layout

On the main page, you can view Live video, playback and configuration. Parameter setting, Video control, Web login and logout can be performed by PC. The main page layout shown in Figure 2-6. For more details, please refer to Table 2-1.

Figure 2-6 Main page layout



Table 2-1 Functions on the main page

No.	Function	Description
1	Live video	Real-time videos are played in this area. You can also set sensor parameters.
2	Playback	You can query the playback videos in this area. <b>NOTE</b> The playback can only be viewed when there is video in SD card.
3	Device configuration	You can choose a menu to set device parameters, including the device information, audio and video streams, alarm setting, and privacy mask function.
4	Change password	You can click  to change the password.
5	Sign Out	You can click  to return to the login page.
6	Stream	There are three streams. Choose one type from drop-down

No.	Function	Description
		list.
7	Pause/Start	Click to pause or play live video.
8	Live/Smooth	Switch image quality.
9	Audio	Open or close audio.
10	Interphone	Open or close interphone.
11	Sensor setting	Click to set sensor setting.
12	Snapshot	Click for snapshot.
13	Local record	Click the icon, it will record video and save.
14	Intelligent analysis	Click to start intelligent analysis, action track will appear. Select stream 2 to view, it will show target information and video stream draw line.



### NOTE





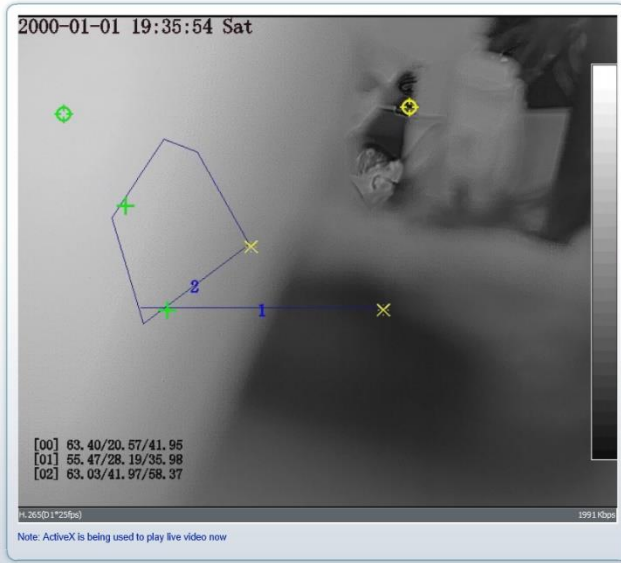
1. When the device generates an alarm, the alarm icon  is displayed. You can click  to view the alarm information. When the device accepts an alarm signal, the alarm icon will display within 10s in the web management system.
2. When the device encounters an exception, the fault icon  is displayed. You can click  to view the fault information.
3. PTZ function can only be used for connecting to pan & tilt device.

Figure 2-7 The icon



: The lowest temperature of the full screen.



: The highest temperature of the full screen.



: The lowest temperature of the area.




: The highest temperature of the area.


----End

## 2. 4 Changing the Password

### Description

You can click  to change the current login password.

### Procedure

Step 1 Click  in the upper right corner of the main page.

The **Change Password** dialog box is displayed, as shown in Figure 2-8.

Figure 2-8 Modify Password Dialog Box

Change Password

Old Password

New Password

Confirm

Password Advice:

1. Advice the password length of eight characters.
2. Advice the password includes numbers, capital letters, lowercase letters and special characters.
3. Advice the password can not be the same as username.

OK Cancel

 **NOTE**

The change password page will be displayed if you don't change the default password when you log in the system for the first time.

Step 2 Enter the old password, new password, and confirm password.

Step 3 Click **OK**.

If the message "Change own password success" is displayed, the password is successfully changed. If the password fails to be changed, the cause is displayed. (For example, the new password length couldn't be less than eight.)

Step 4 Click **OK**.

The login page is displayed.

**----End**

## 2.5 Setting Local Network Parameters

### Description

Local network parameters include:

- IP protocol
- IP address
- Subnet mask
- Default gateway
- Dynamic Host Configuration Protocol (DHCP)
- Preferred Domain Name System (DNS) server



Alternate DNS server


MTU

## Procedure

Step 1 Choose **Configuration > Device > Local Network**.

The **Local Network** page is displayed, as shown in Figure 2-9.

Figure 2-9 Device information

 **Local Network**

---

Network Card ID

IP Protocol

---

DHCP  OFF

IP Address

Subnet Mask

Default Gateway

---

Preferred DNS Server

Alternate DNS Server

MTU(1280-1500)

---

Step 2 Set the parameters according to Table 2-2.

Table 2-2 Local network parameters

Parameter	Description	Setting
IP Protocol	IPv4 is the Internet Protocol which adopts a 32-bit address.	[Setting method] Select a value from the drop-down list box. [Default value] <b>IPv4</b>

Parameter	Description	Setting
DHCP	The device automatically obtains the IP address from the DHCP server.	[Setting method] Click the option button.  NOTE To query the current IP address of the device, you must query it on the platform based on the device name.
DHCP IP	IP address that the DHCP server assigned to the device.	N/A
IP Address	Device IP address that can be set as required.	[Setting method] Enter a value manually. [Default value] <b>192.168.0.121</b>
Subnet Mask	Subnet mask of the network adapter.	[Setting method] Enter a value manually. [Default value] <b>255.255.255.0</b>
Default Gateway	This parameter must be set if the client accesses the device through a gateway.	[Setting method] Enter a value manually. [Default value] <b>192.168.0.1</b>
Preferred DNS Server	IP address of a DNS server.	[Setting method] Enter a value manually. [Default value] <b>192.168.0.1</b>
Alternate DNS Server	IP address of a domain server. If the preferred DNS server is faulty, the device uses the alternate DNS server to resolve domain names.	[Setting method] Enter a value manually. [Default value] <b>192.168.0.2</b>
MTU	Set the maximum value of network transmission data packets.	[Setting method] Enter a value manually.  NOTE The MTU value is range from 1280 to 1500, the default value is 1500, Please do not change it arbitrarily.

**Step 3 Click OK.**

If the message "Apply success" is displayed, click OK. The system saves the settings. The message "Set network parameters success, Please login system again" is displayed. Use the new IP address to log in to the web management system.

If the message "Invalid IP Address", "Invalid Subnet Mask", "Invalid default gateway", "Invalid primary DNS", or "Invalid space DNS" is displayed, set the parameters correctly.

**NOTE**

If you set only the **Subnet Mask**, **Default Gateway**, **Preferred DNS Server**, and **Alternate DNS Server** parameters, you do not need to log in to the system again.

You can click **Reset** to set the parameters again if required.

**----End**

## 3 Thermal Settings

---

### 3.1 Temperature Parameters

Temperature parameters include: temperature unit, ambient temperature, cavity temperature, correctional coefficient area temperature display mode, and so on.



#### **NOTE**

The temperature and length unit are used for all parameters which occur at the software.

The Open Temperature Measure should be enable in advance, if not there are no temperature showing on screen, and the alarms settings are invalid.

#### **Operation Procedure**

Step 1 Choose **Configuration > Thermal > Temperature Parameters**.

The **Temperature Parameters** page is displayed, as shown in Figure 3-1.

Figure 3-1 Temperature Parameters Interface

 Temperature Parameters

Temperature Measurements
 ON

Temperature Units	<input type="text" value="Celsius"/>
Length Units	<input type="text" value="Meters"/>
Cavity Temperature	<input type="text" value="35.17"/>
Correction Coefficient	<input type="text" value="0.00"/>
Area ID Display Mode	<input type="text" value="Area ID"/>
Area Temperature Display Mode	<input type="text" value="Low Left"/>
Font Border	<input checked="" type="checkbox"/> ON
Font Size	<input type="text" value="Mid"/>
Area Temperature Type	<input type="text" value="Highest Temperature"/>
Measure Mode	<input type="text" value="General"/>
Display Alarm Area	<input type="checkbox"/> OFF
Area Alarm Interval (1-1800s)	<input type="text" value="10"/>
Area Alarm Delay (0-10s)	<input type="text" value="0"/>
Temperature Range	<input type="text" value="-20.0 ~ 150.0"/>
Prevent Overheating	<input type="text" value="Auto"/>
Duration (5-60s)	<input type="text" value="60"/>

Step 2 Set the parameters according to Table 3-1.

Table 3-1 Temperature Parameters

Parameter	Description	Setting
Temperature Measurements	Enable to open temperature measure.	[Setting method] Enable
Temperature Units	Celsius and Fahrenheit temperature units are available.	[Setting method] Select a value from the drop-down list box. [Default value] <b>Celsius</b>

Parameter	Description	Setting
Length Units	Meters and Feet	[Setting method] Select a value from the drop-down list box. [Default value] <b>Meters</b>
Cavity Temperature	The cavity temperature of camera.	N/A
Correction Coefficient	Correction coefficient is refer to the deviation of measured object temperature and actual temperature. For example: 1. The measured object temperature is 30, and actual temperature is 37, so the correction coefficient should be <b>7</b> . 2. The measured object temperature is 37, and actual temperature is 30, so the correction coefficient should be <b>-7</b> .  NOTE User should contact the technical support staff of our company at this condition to make sure to apply.	[Setting method] Enter a value manually. [Default value] <b>0.00</b>
Area ID Display Mode	Choose the area ID display mode, Area ID or Area name.	[Setting method] Select a value from the drop-down list box. [Default value] <b>Area ID</b>
Area Temperature Display Mode	The display position of temperature information on the live-video image.	[Setting method] Select a value from the drop-down list box. [Default value] <b>Low left</b>
Font Border	Enable to bold the font.	[Setting method] Enable or disable [Default value] <b>Disable</b>

Parameter	Description	Setting
Font Size	Custom font size. There are three sizes can be chosen.	[Setting method] Select a value from the drop-down list box.
Area Temperature Type	There are three types of area temperature.	[Setting method] Select a value from the drop-down list box. [Default value] <b>Highest Temperature</b>
Measure Mode	Choose the measure mode from the drop-down list. Different models may have different mode, please refer to actual product.	[Setting method] Select a value from the drop-down list box. [Default value] <b>General</b>
Display Alarm Area	N/A	[Setting method] Enable or disable [Default value] <b>Disable</b>
Area Alarm Interval (1-1800s)	N/A	[Setting method] Enter a value manually ranges from 1 to 1800. [Default value] <b>10</b>
Area Alarm Delay(0-10s)	When the area detects alarm actions, it will delay for the setting time. The default value is 0.	[Setting method] Enter a value manually ranges from 1 to 10. [Default value] <b>0</b>
Temperature range	It depends the device, different devices have different modes, there are two ranges, such as -20 °C -150°C, -40 °C-150°C.	[Setting method] Select a value from the drop-down list box.
Prevent Overheating	Open, if temperature of the testing area is too high, you can enable prevent over heat function, there are two types, manual and auto. <b>The auto mode is advised.</b>	[Setting method] Select a value from the drop-down list box.

Parameter	Description	Setting
Temper Duration(5-60s)	Prevent over heat' mode is auto, the control cover will block for duration time automatically if over heat.	[Setting method] Enter a value manually ranges from 5 to 60.
Control Cover	<b>It is professional operation.</b> When prevent over heat mode is manual, the users should choose the action manually, such as pick up, lay down.	[Setting method] Select a value from the drop-down list box.

Figure 3-2 Advanced Interface

Table 3-2 Advance Parameters

Parameter	Description	Setting
Dimming Mode	There are auto and manual modes. Auto: It will show on temperature item depend on the full screen temperature. Manual: it will show on the manual value.	[Setting method] Select a value from the drop-down list box. [Default value] <b>Auto</b>
Greater Prominent	Enable that, the image will show the setting color if the temperature is higher than set value.	[Setting method] Enter a value manually. Choose one color to show.



Parameter	Description	Setting
Section Prominent	Enable that, the image will show the setting color if the temperature is between minimum and maximum temperature.	[Setting method] Enter a value manually. Choose one color to show.
Less Prominent	Enable that, the image will show the setting color if the temperature is lower than set value.	[Setting method] Enter a value manually. Choose one color to show.
Raw Data Upload Interval(F/S)	Interval of uploading the raw data.	[Setting method] Select a value from the drop-down list box. [Default value] <b>1</b>
Mix Stream Mode	This function is used for mixing thermal and visible imaging. For this model, there is only thermal channel, so it is closed.	[Default value] <b>Close</b>

----End

## 3.2 Ambient Temperature

Set the ambient temperature of camera, click “Apply” to save the setting, click “Refresh” the cavity temperature will be refresh based on ambient temperature.

Figure 3-3 Ambient Temperature

 Ambient Temperature

Ambient Temperature	<input type="text" value="25.00"/>	°C
Cavity Temperature	<input type="text" value="23.23"/>	°C

Table 3-3 parameter of Ambient Temperature

Parameter	Description	Setting
Ambient Temperature	Environment temperature of camera.	[Setting method] Enter the temperature of ambient. [Default value] <b>25</b>
Cavity temperature	Set the ambient temperature, click “Apply”, click “Refresh”, the camera will get the value automatically.	---

----End

## 3.3 Temperature Alarm

### Operation Procedure

Step 1 Choose **Configuration > Thermal > Temperature Alarm**.


The **Temperature Alarm** page is displayed, as shown in Figure 3-4.

Figure 3-4 Temperature Alarm Configuration

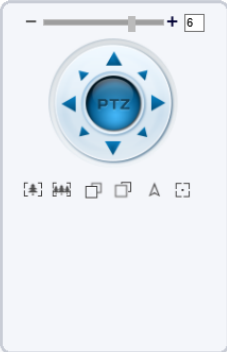
Alarm Configuration

Channel
1

Measure Mode
General



- + | 6



Enable	ID	Name	Type	Alarm Type	Warning Value	Alarm Value	Maximum Alarm Va	Duration(1-1)
<input checked="" type="checkbox"/>	0	Area0	Rectangle	Threshold Alarm	48.00	50.00	60.00	1.00
<input type="checkbox"/>	1	Area1	Point	Threshold Alarm	48.00	50.00	60.00	1.00
<input type="checkbox"/>	2	Area2	Point	Threshold Alarm	48.00	50.00	60.00	1.00
<input type="checkbox"/>	3	Area3	Point	Threshold Alarm	48.00	50.00	60.00	1.00
<input type="checkbox"/>	4	Area4	Point	Threshold Alarm	48.00	50.00	60.00	1.00
<input type="checkbox"/>	5	Area5	Point	Threshold Alarm	48.00	50.00	60.00	1.00
<input type="checkbox"/>	6	Area6	Point	Threshold Alarm	48.00	50.00	60.00	1.00
<input type="checkbox"/>	7	Area7	Point	Threshold Alarm	48.00	50.00	60.00	1.00


Refresh
Apply

Step 2 Set the parameters according to Table 3-4

Table 3-4 Temperature Alarm Configuration

Parameter	Description	Setting
Channel	N/A	[Setting method] Select a value from the drop-down list box. [Default value] 1
Measure Mode	Set at temperature parameter interface.	N/A

Parameter	Description	Setting
Enable	Tick to enable the area alarm	[Setting method] Tick
Name	Area name of temperature area.	[Setting method] Enter a value manually.
Type	Type of temperature area. ID 0 is default rectangle area, which is full screen.	[Setting method] Select a value from the drop-down list box. [Default value] <b>Rectangle/Point</b>
Alarm Type	Threshold alarm, temperature difference alarm, section alarm, temperature rise alarm are available for alarm type. Section Alarm: if the temperature value is among the set temperature range, it will generate the alarm. Temperature rise alarm means it the rising temperature value is more than the set value, it will generate the alarm. It need to set the alarm schedule	[Setting method] Select a value from the drop-down list box. [Default value] <b>Threshold alarm</b>
Warning Value	Camera will trigger warning alarm when the object temperature reaches the warning value.	[Setting method] Enter a value manually. [Default value] <b>48</b>
Alarm Value	Camera will alarm when the object temperature reaches the alarm value.	[Setting method] Enter a value manually. [Default value] <b>50</b>
Maximum Alarm Value	At section alarm type, the device would not alarm when the temperature is higher than maximum alarm value.	[Setting method] Enter a value manually. [Default value] <b>60.00</b>
Duration (1-10s)	Choose temperature rise alarm, set the duration, the temperature rise the value and it is kept for duration setting, the alarm is triggered successfully.	

Parameter	Description	Setting
Emission Rate	The emission rate is the capability of an object to emit or absorb energy. The emission rate should be set only when the target is special material. The emission rate list refers to 0B Common Emission Rate	[Setting method] Enter a value manually. [Default value] <b>0.95</b>
Distance (M)	The distance between camera and target.	[Setting method] Enter a value manually. [Default value] <b>15</b>  <b>NOTE</b> Enter actual distance when the distance between camera and target is less than 15m. Enter 15 when the distance between camera and target is great than or equal to 15m.
Reflect Enable	When there are some high temperature objects on scene, and the temperature reflect to the other object, you can enable this function to calibrate the temperature.	[Setting method] Tick to enable
Reflect Temperature	The temperature of high temperature object.	[Setting method] Enter a value manually. [Default value] <b>50.00</b>
Ignore Object	Enable to shield the temperature of area capturing AI object.	[Setting method] Select a value from the drop-down list box.
Alarm	Enable or disable the alarm output and linkage of area.	[Setting method] Tick the alarm output channel .
Masking	Enable, the device will shield this area's temperature.	[Setting method] Tick to shield.

Parameter	Description	Setting
Group ID	<p>The ID can be chosen into one of six groups, or no group. The group will be alarm following as the next rules:</p> <p>A=The highest temperature of groups (the highest temperature of N regions is the largest)</p> <p>B=Average temperature of groups (average temperature of N regions)</p> <p>WA=Warning value</p> <p>AA=Alarm value</p> <p>a. If <math>A-B \geq WA</math>, a temperature difference warning signal is generated ---&gt; (the one with the largest difference between the N areas and the average temperature is the alarm area flashing)</p> <p>b. If <math>A-B \geq AA</math>, a temperature difference alarm signal is generated ---&gt; (the one with the largest difference between the N areas and the average temperature is the alarm area flashing)</p> <p>c. If the warning and alarm conditions are met at the same time, the alarm signal will be generated first.</p>	<p>[Setting method]</p> <p>Select a value from the drop-down list box.</p>

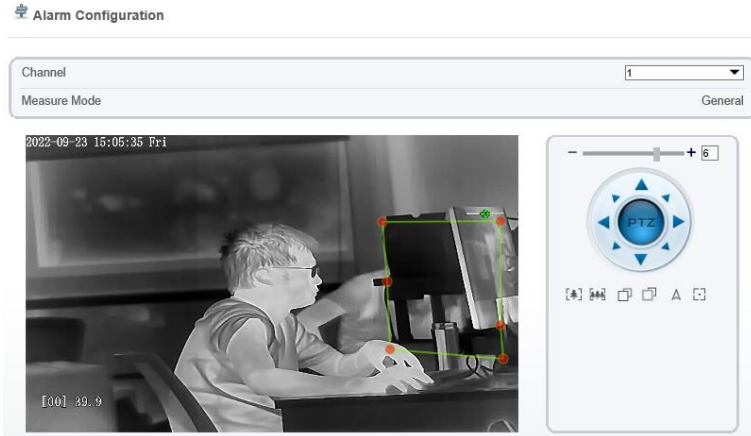
### Step 3 Set temperature area.

Select an area ID

Select type from drop-list.

Press and hold the left mouse button, and drag in the video area to draw a temperature area, as shown in Figure 3-5.

Figure 3-5 Temperature Area Setting Interface



Click **Apply**, the message “Apply success” pops up, the temperature area is set successfully.

#### Delete a temperature area:

Select an area ID.

Click the temperature area and right-click.

Click **Apply**, the message “Apply success” pops up, the temperature area is deleted successfully.

Step 4 Click **Apply**.

The message "Apply success" is displayed, the system saves the settings.

----End

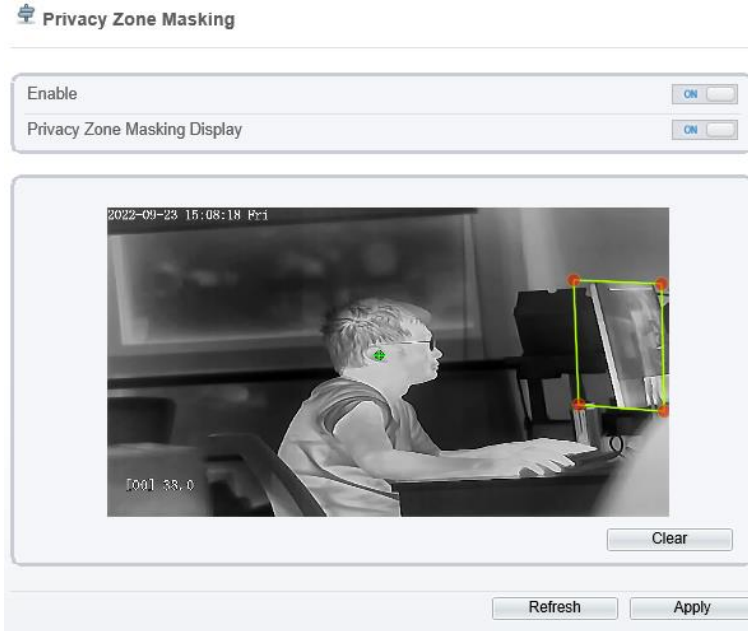
## 3.4 Privacy Zone Masking

Privacy zone masking is meaning that the camera will not to detect the temperature of masking area.

### Operation Procedure

Step 1 Choose **Configuration > Thermal > Privacy Zone Masking**.

Figure 3-6 Privacy Zone Masking



Step 2 Enable the Privacy Zone Masking.

Step 3 Enable **Privacy Zone Masking Display**, then the setting masking areas will show on live video.

Step 4 Left-click to select polygon area, right-click to save. Click **Clear** to clear the masking area

Step 5 Click **Apply** to save the settings.

----End

## 3.5 Schedule Linkage

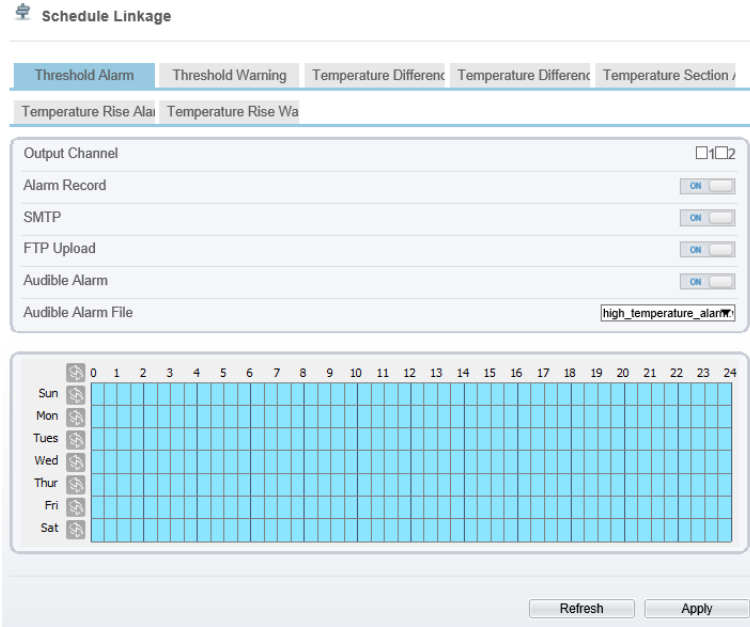
### Operation Procedure

Step 1 Choose **Configuration > Thermal > Schedule Linkage**.

The **Schedule Linkage** page is displayed, as shown in Figure 3-7



Figure 3-7 Schedule Linkage



Step 2 Tick the output channel.

Step 3 Enable wanted linkage: “Alarm Record”, “SMTP”,”FTP Upload”, “Audible Alarm” button.

Step 4 Set schedule linkage.

**Method 1:** Left click to select any time point within 0:00-24:00 from Monday to Sunday as shown in Figure 3-7.

**Method 2:** Hold down the left mouse button, drag and release mouse to select the alarm time within 0:00-24:00 from Sunday to Saturday.

**NOTE**

When you select time by dragging the cursor, the cursor cannot be moved out of the time area. Otherwise, no time can be selected.

**Method 3:** Click in the alarm time page to select the whole day or whole week.

**Deleting alarm time:** Click again or inverse selection to delete the selected alarm time.

Step 5 Click **Apply**.

The message "Apply success" is displayed, the system saves the settings.

**NOTE**

Alarm output: Users should connect the external alarm device (such as siren) to alarm output cables. The parameter can be set at “ Configuration > Alarm > Alarm Output” interface, as shown in Figure 3-8.

Figure 3-8 Alarm Output

Table 3-5 Alarm Output

Parameter	Description	Setting
Alarm Output	ID of the alarm output channel. NOTE The number of alarm output channels depends on the device model.	[Setting method] Select a value from the drop-down list box. [Default value] <b>1</b>
Name	Alarm output channel name.	[Value range] 0 to 32 bytes
Valid Signal	The options are as follows: <b>Close:</b> An alarm is generated when an external alarm signal is received. <b>Open:</b> An alarm is generated when no external alarm signal is received.	[Setting method] Select a value from the drop-down list box. [Default value] <b>Close</b>

Parameter	Description	Setting
Alarm Output Mode	<p>When the device receives I/O alarm signals, the device sends the alarm information to an external alarm device in the mode specified by this parameter. The options include the switch mode and pulse mode.</p> <p>NOTE</p> <ul style="list-style-type: none"> <li>• If the switch mode is used, the alarm frequency of the device must be the same as that of the external alarm device.</li> <li>• If the pulse mode is used, the alarm frequency of the external alarm device can be configured.</li> </ul>	<p>[Setting method] Select a value from the drop-down list box. [Default value] <b>Switch Mode</b></p>
Alarm Time (ms) (0: Continuous)	Alarm output duration. The value <b>0</b> indicates that the alarm remains valid.	<p>[Setting method] Enter a value manually. [Default value] 0 [Value range] 0 to 86400 seconds</p>
Timing Alarm Output	Enable timing alarm output, set the schedule to time alarm.	<p>[Setting method] Enable [Default value] <b>OFF</b></p>
Manual Control	Control the alarm output.	N/A

Alarm Record: Users insert the SD card in camera. The recording time is set at “**Configuration > Device Record > Record Policy**” interface.

SMTP: At “**Configuration > Network > SMTP**” interface, users should set the parameters of SMTP in advance, as shown in Figure 3-9.

Figure 3-9 SMTP

The screenshot shows the SMTP configuration interface with the following fields and values:

- SMTP Server Address: [Empty text box]
- SMTP Server Port: 25
- User Name: [Empty text box]
- Password: [Empty text box]
- Send anonymously:
- Sender E-mail Address: [Empty text box]
- Recipient\_E-mail\_Address1: [Empty text box]
- Recipient\_E-mail\_Address2: [Empty text box]
- Recipient\_E-mail\_Address3: [Empty text box]
- Recipient\_E-mail\_Address4: [Empty text box]
- Recipient\_E-mail\_Address5: [Empty text box]
- Transport Mode: No Encrypt (dropdown menu)
- Send Interval(0-60S): 0

Buttons at the bottom include "Email Test", "Refresh", and "Apply".

Table 3-6 SMTP Parameters

Parameter	Description	Setting
SMTP Server Address	IP address of the SMTP server.	[Setting method] Enter a value manually.
SMTP Server Port	Port number of the SMTP server.	[Setting method] Enter a value manually. [Default value] <b>25</b>
User Name	User name of the mailbox for sending emails.	[Setting method] Enter a value manually.
Password	Password of the mailbox for sending emails.	[Setting method] Enter a value manually.
Sender E-mail Address	Mailbox for sending emails.	[Setting method] Enter a value manually.

Parameter	Description	Setting
Recipient_Email_Address 1	(Mandatory) Email address of recipient 1.	[Setting method] Enter a value manually.
Recipient_Email_Address 2	(Optional) Email address of recipient 2.	
Recipient_Email_Address 3	(Optional) Email address of recipient 3.	
Recipient_Email_Address 4	(Optional) Email address of recipient 4.	
Recipient_Email_Address 5	(Optional) Email address of recipient 5.	
Attachment Image Quality	A higher-quality image means more storage space. Set this parameter based on the site requirement.	N/A
Transport Mode	Email encryption mode. Set this parameter based on the encryption modes supported by the SMTP server.	[Setting method] Select a value from the drop-down list box. [Default value] <b>No Encrypted</b>

FTP Upload: At “**Configuration > Network > FTP**” interface, users should set the parameters of FTP upload in advance, as shown in Figure 3-10.

Figure 3-10 FTP Upload


The screenshot shows the 'FTP Upload' configuration window. It includes an 'ON' toggle switch in the top right corner. The main area contains several input fields: 'FTP Address', 'FTP Port' (with the value '0'), 'Account', 'Password', and 'FTP Path'. The 'Media Type' is a dropdown menu currently set to 'Snapshot'. A 'Test FTP' button is located at the bottom right of the form. Below the form, there are two buttons: 'Refresh' and 'Apply'.

























Table 3-7 FTP Upload Parameters

Parameter	Description	Setting
FTP Upload	Indicates whether to enable the FTP service.	[Setting method] Click the button on. [Default value] <b>OFF</b>
FTP Address	IP address of FTP server.	[Setting method] Enter a value annually.
FTP Port	Port of FTP server.	[Setting method] N/A [Default value] <b>21</b>
Account	FTP server account.	[Setting method] Enter a value annually.
Password	FTP server Password.	[Setting method] Enter a value annually.
FTP Path	FTP Path to save the JPG image.	[Setting method] Enter a value annually.
Media Type	The media type of sending to FTP, snapshot or video clip.	[Setting method] Select a value from the drop-down list box. [Default value] Snapshot









Audible Alarm output: At “ **Configuration > Alarm > Audible Alarm Output**” interface, users should set the parameters of Audible Alarm output in advance, as shown in Figure 3-11.

Figure 3-11 Audible Alarm Output

 **Audible Alarm Output**

ID	FileName	Cycle Number	Listen Test	Operate
0	high_temperature_alarm.wav	1		
1	normal_temperature.wav	1		
2	low_temperature_alarm.wav	1		
3	hello_welcome.wav	1		
4	verification_success.wav	1		
5	verification_failed.wav	1		
6	temperature_rise_warning.wav	1		
7	temperature_rise_alarm.wav	1		
8	temperature_range_alarm.wav	1		
9	temperature_diff_alarm.wav	1		
10	temperature_diff_warning.wav	1		
11	high_temperature_warning.wav	1		

	0	1	2	3	4	5	6	7	8	9	10	11	12	13	14	15	16	17	18	19	20	21	22	23	24
Sun																									
Mon																									
Tues																									
Wed																									
Thur																									
Fri																									
Sat																									



User can set the audio file manually. Click  to upload the audible file (The type should be WAV, size must be less than 250 Kb, the bit rate should be 128 kbps.), as shown in Figure 3-12.

Figure 3-12 Upload Audio File

**Upload Audio File** ✕

Please select audio file 

----End

## 3.6 Defect Pixel Correction

### Description

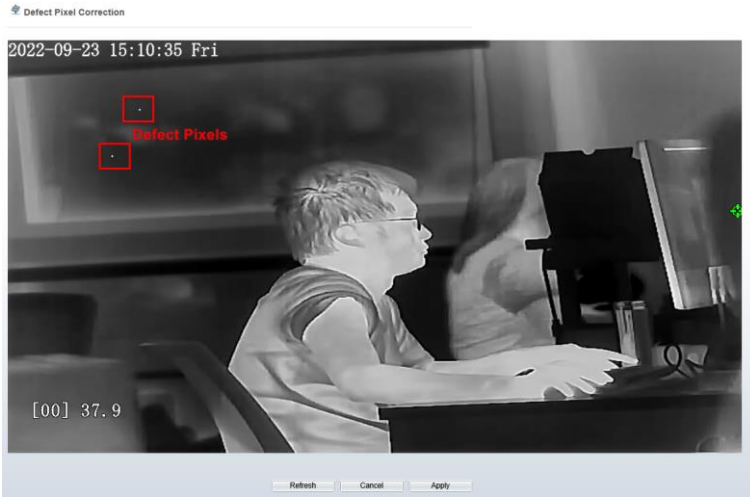
The points that can't move when the environment or scenario change is defect pixel. You can correct the these points manually.

### Procedure

Step 1 Choose **Configuration > Thermal > Defect Pixel Correction**.

The Defect Pixel Correction page is displayed, as shown in Figure 3-13.

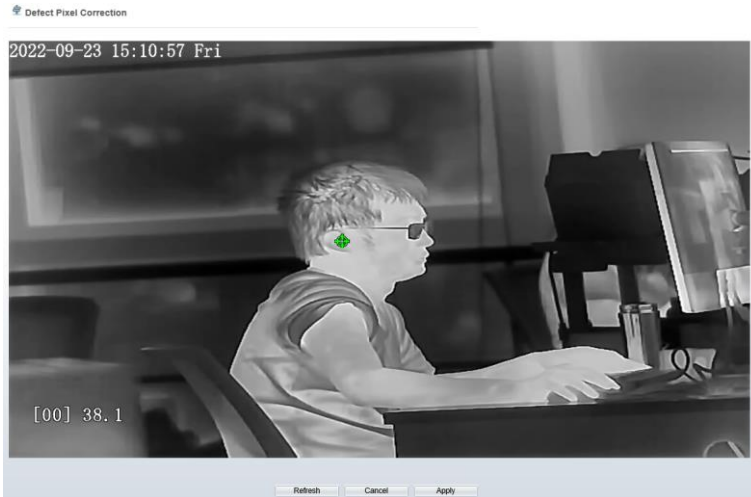
Figure 3-13 Defect Pixel Correction



Step 2 Click the white points one by one at image, click **Apply** to recover the bad point, as shown in Figure 3-14.



Figure 3-14 Recover Defect Pixel



Step 3 Click **Reset** to return the previous settings.

Step 4 Click **Apply**. The message "Apply success" is displayed, the system saves the settings.

----End

# 4 Image Settings

## 4.1 Image Settings Interface

### Operation Procedure

Step 1 On the Microsoft Edge IE mode interface or the client software interface, select and right-click the surveillance image to set, as shown in Figure 4-1.

Figure 4-1 Right-click Configuration

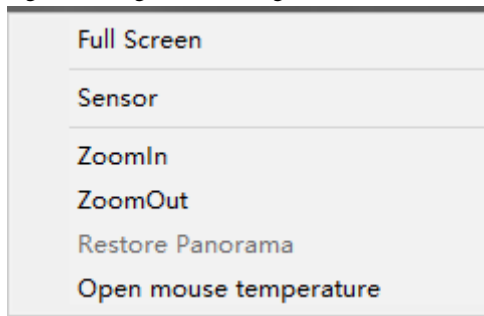
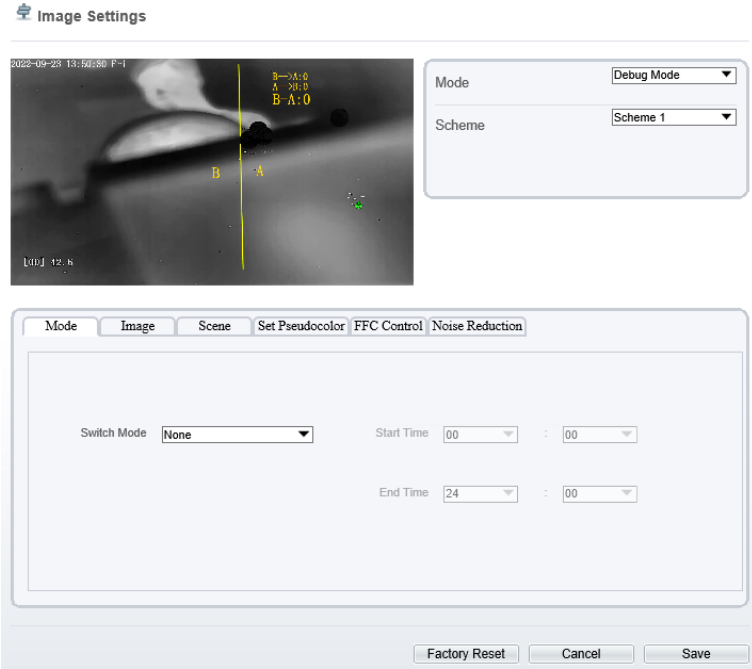


Table 4-1 Parameters of Right-click

parameters	Description
Full screen	Click to display live video in full screen.
Sensor	Enter to adjust image configuration.
Zoom in / zoom out	Click to zoom in or zoom out the image, and the middle mouse button is used to quickly zoom image.
Open mouse temperature	Turn on, the temperature of mouse's location shows on screen.

Or enter “**Configuration > Image Settings**” interface to set, as shown in Figure 4-2.

Figure 4-2 Thermal Channel Image Settings



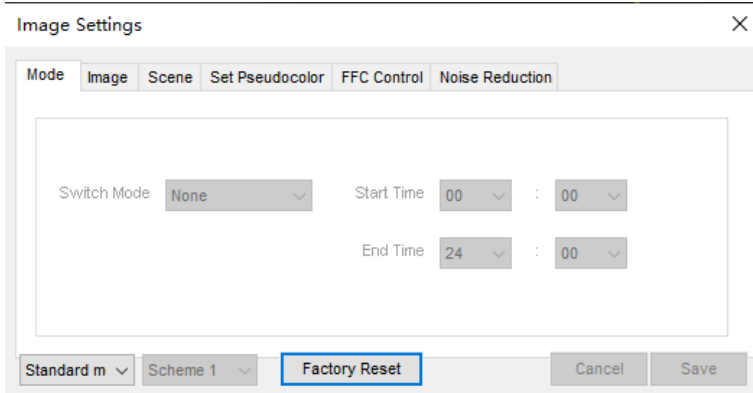
Step 2 Choose **Image settings**. The dialog box is displayed, as shown in Figure 4-3.

----End

## 4.2 Mode

Figure 4-3 shows the **Mode** interface.

Figure 4-3 Mode Interface



### Operation Procedure

Step 2 Click **Standard** in the lower left corner of Image Settings, and choose **Debug Mode**.

Step 3 Choose switch mode form drop-down list.

Step 4 Set the Start Time.

Step 5 Set the End Time.

Step 6 Click **Save**, the message "Save succeed" is displayed, the system saves the settings.

----End

## 4.3 Images

Figure 4-4 shows the **Image** interface.

Figure 4-4 Image Interface



Step 2 Click **Standard** in the lower left corner of Image Settings, and choose **Debug Mode**.

Step 3 Drag the slider to adjust parameter of image.

**Brightness:** It indicates the total brightness of an image. As the value increases, the image becomes brighter. It ranges from 0 to 100.

**Contrast:** It indicates the contrast between the bright part and the dark part of an image. As the value increases, the contrast increases. It ranges from 0 to 100.

**Sharpness:** It indicates the contrast between definition and edge sharpness. The higher value, the higher definition and greater distortion. It ranges from 0 to 100.

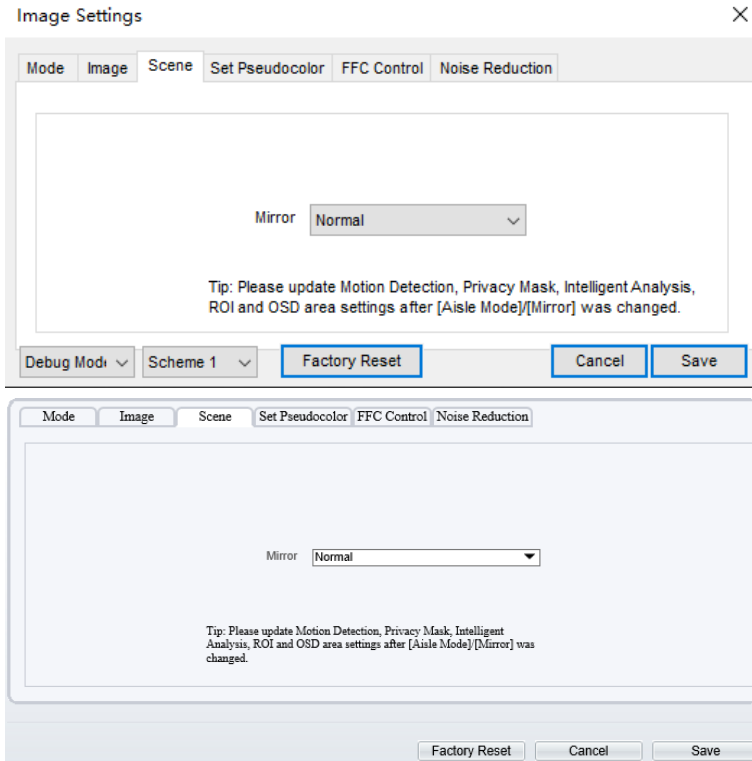
Step 4 Click **Save**, the message "Save succeed" is displayed, the system saves the settings.

----End

## 4.4 Scene

Figure 4-5 shows the **Scene** interface.

Figure 4-5 Scene Interface



Step 2 Click **Standard** in the lower left corner of Image Settings, and choose **Scene**

Step 3 Choose mirror mode from drop-list.

Step 4 Click **Save**, the message "Save succeed" is displayed, the system saves the settings.

#### NOTE

Mirror providing the selection of image pixel locations.

Normal: the image is not flipped.

Horizontal: the image is flipped left and right.

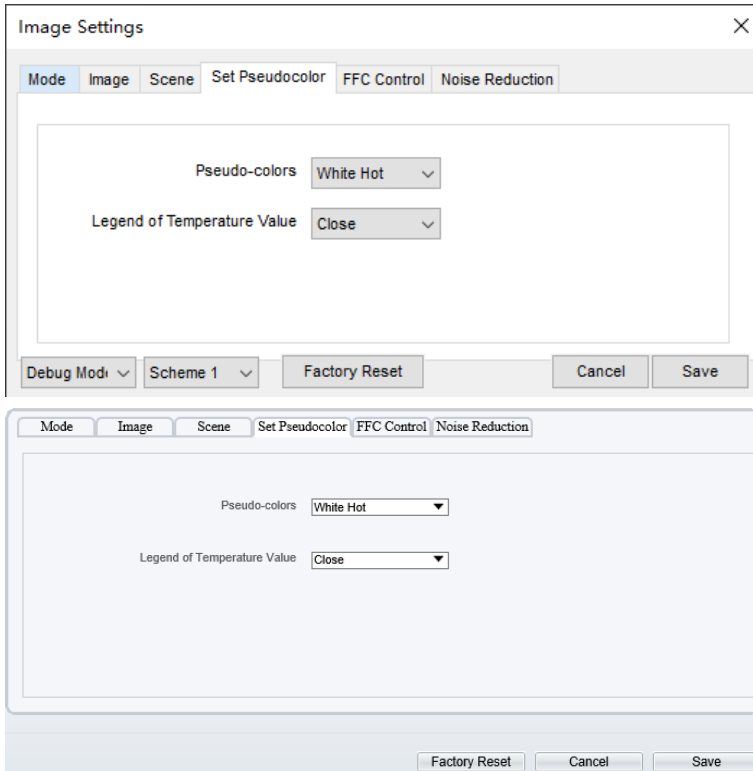
Vertical: the image is flipped up and down.

----End

## 4.5 Set Pseudocolor

Figure 4-6 shows the **Set Pseudocolor** interface.

Figure 4-6 Set Pseudocolor Interface



Step 2 Click **Standard** in the lower left corner of Image Settings, and choose **Set pseudocolor**

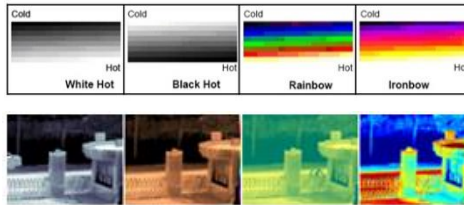
Step 3 Choose Pseudo-colors modes from the drop-down list.

Step 4 Enable or disable the Legend of Temperature Value.

Step 5 Click **Save**, the message "Save succeed" is displayed, the system saves the settings.

## NOTE

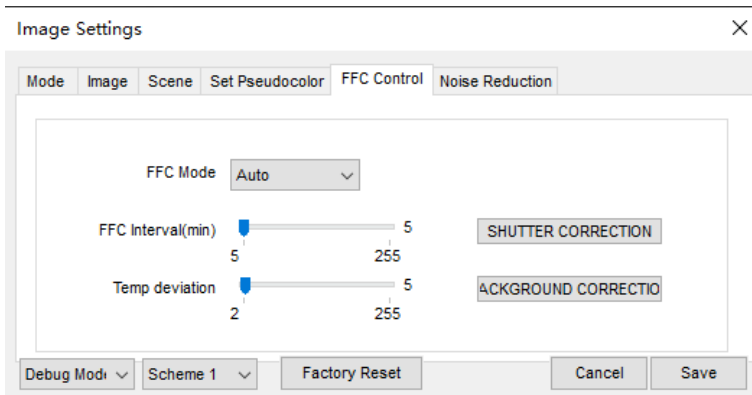
The temperatures of the temperature fields detected by the thermal imaging camera are separately mapped to values ranging from 0 to 255 by the algorithm. In the black/white display mode, this range is converted to the gray scale tones. For example, 0 indicates completely black, and 255 indicates completely white. The temperature field of the scene is converted to images by using the grayscale ranging from 0 to 255. Different polarity modes can be converted to different display images. The most common setting is white hot (a hotter object is displayed brighter than a colder object) or black hot (a hotter object is displayed darker than a colder object). The difference between two modes lies in that the temperatures corresponding to the darker one and the lighter one is reversed. Other modes include rainbow, ironbow, HSV, autumn, bone and so on.



## 4.6 FFC Control

Figure 4-7 shows the **FFC Control** interface.

Figure 4-7 FFC Control Interface





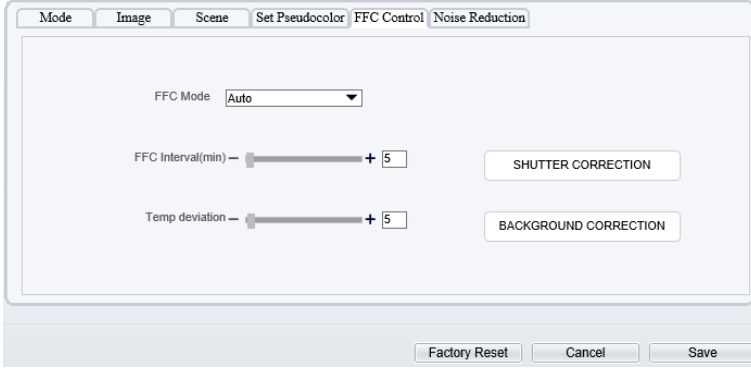


Table 4-2 lists the parameters on the FFC control interface.

Table 4-2 Parameters on the FFC Control Interface

Parameter	Description	Setting
FFC Mode	<p>The internal of the thermal imaging camera may comprise the mechanical action correction mechanism that can periodically improve the image quality. This component is called flat field correction (FFC). When controlling the FFC, the FFC shields the sensor array, so that each portion of the sensor can collect uniform temperature fields (flat field). By means of FFC, the camera can update the correction coefficients to output more uniform images. Throughout the FFC process, the video image is frozen for two seconds and a static-frame image is displayed. After the FFC is complete, the image is automatically recovered. Repeated FFC operations can prevent the grainy and image degradation problems. The FFC is especially important when the temperature of the camera changes. For example, after the camera is powered on or the ambient temperature is changed, you should immediately perform the FFC.</p> <p><b>Auto:</b> In the Automatic FFC mode, the camera performs FFC whenever its temperature changes by a specified amount or at the end of a specified period of time (whichever comes first). When this mode is selected, the FFC interval (minutes) ranges from 5 to 255 minutes. The temperature change of the camera is based on the temperatures collected by the internal temperature probe. The</p>	<p>[How to set]                      Select from the drop-down list box.                      [Default value]  <b>Auto</b></p>

Parameter	Description	Setting
	<p>temperature of the camera sharply changes when the camera is powered on. The FFC is relatively frequent, which is normal.</p> <p><b>Manual:</b> In the manual FFC mode, the camera does not automatically perform the FFC based on the temperature change or the specified period. You can press the Do FFC button to select the manual FFC mode. When you feel that the image is obviously degraded but the automatic FFC is not performed, you can use the manual FFC function to check whether the image quality can be improved.</p>	
FFC interval (min)	In the automatic FFC mode, the FFC interval ranges from 5 to 255 minutes. When the time reach to setting value, the camera does shutter adjust operation automatically.	[How to set] Select by dragging the slider. [Default value] <b>5</b>
Temp deviation	In the automatic FFC mode, the temp deviation value ranges from 0.2 to 25.5 degree centigrade. When the time reach to setting value, the camera does background adjust operation automatically.	[How to set] Select by dragging the slider. [Default value] <b>5</b>
SHUTTER CORRECTION	Click the icon and the camera performs the action.	Manually
BACKGROUND CORRECTION	Click the icon and the camera performs the action.	Manually

----End

## 4.7 Noise Reduction

Figure 4-8 shows the **Noise Reduction** interface.

Figure 4-8 Noise Reduction Interface

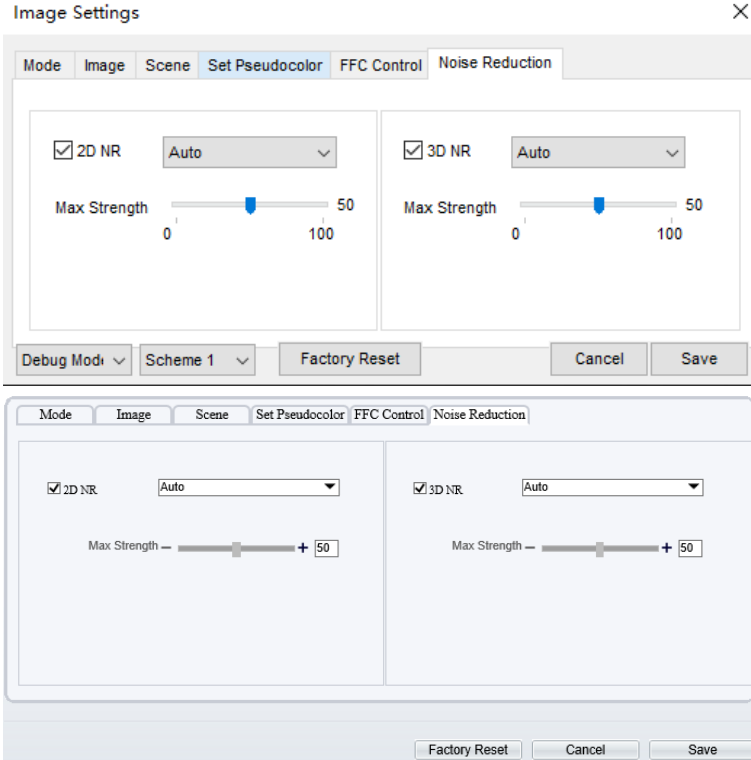


Table 4-3 lists the Noise reduction parameters.

Table 4-3 Parameters on the Noise Reduction Interface

Parameter	Description	Setting
2DNR	Decrease the image noise.	[How to set] Select from the drop-down list box. [Default value] <b>Close</b>
3DNR	Decrease the image noise.	[How to set] Select from the drop-down list box. [Default value] <b>Close</b>

----End

# 5 Intelligent Analysis


## 5.1 Intrusion

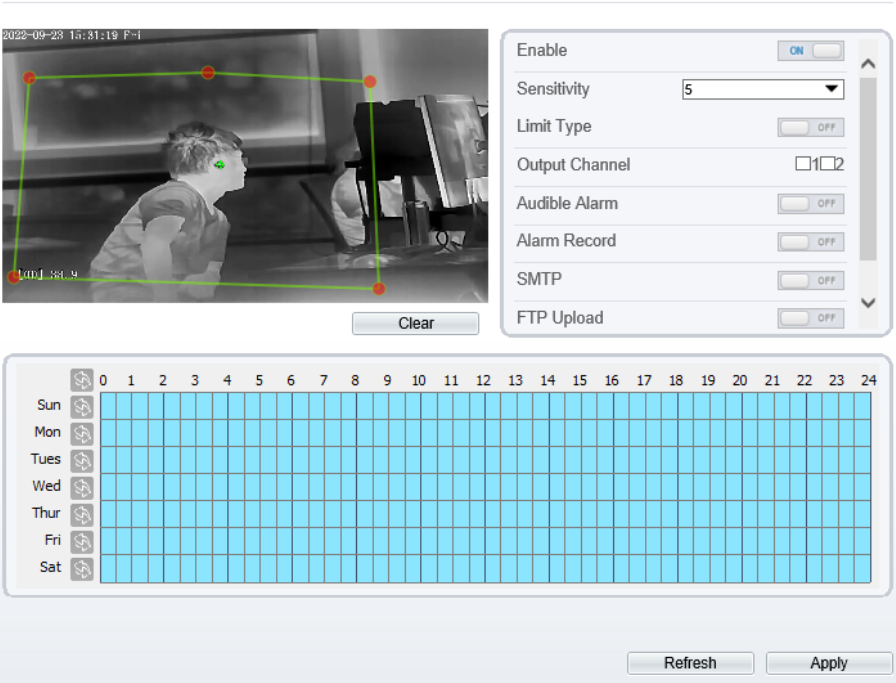
The Intrusion function refers to that an alarm is generated when the targets of specified types (such as person, car, and both person and car) enter the deployment area.

### Operation Procedure

Step 1 Select **Intelligent Analysis** > **Intrusion** to access the **Intrusion** interface, as shown in Figure 5-1.

Figure 5-1 Intrusion Setting Interface

 **Intrusion**



2022-09-28 13:31:19 F-1

Clear

Enable  ON

Sensitivity

Limit Type  OFF

Output Channel  1  2

Audible Alarm  OFF

Alarm Record  OFF

SMTP  OFF

FTP Upload  OFF

	0	1	2	3	4	5	6	7	8	9	10	11	12	13	14	15	16	17	18	19	20	21	22	23	24
Sun																									
Mon																									
Tues																									
Wed																									
Thur																									
Fri																									
Sat																									

Refresh Apply

Step 2 Set all parameters for Intrusion. Table 5-1 describes the specific parameters.

Table 5-1 Intrusion Parameter Description

Parameter	Description	Setting
Enable	Enable the button to enable the alarm.	[How to set] Click Enable to enable. [Default value] <b>OFF</b>
Sensitivity	The sensitivity of detecting the target, when the value is high, the target can be detected easily, but the accuracy will be lower.	[How to set] Choose from the drop-down list [Default value] <b>5</b>
Limit Target Type	Effective alarms are set based on target type, with options of Person or Car, person, car. When the device is used indoors, because of small space and large targets, alarms are triggered by person sometimes even if car is selected, leading to false alarms. It is recommended to set the target type as person for indoor use.	[How to set] Click to enable Limit Target Type. [Default value] <b>OFF</b>
Output Channel	If you check to set the Output Channel and the device is connected to an external alarm indicator, the alarm indicator signals when an alarm is triggered.	[How to set] Click to select an ID.
Audible alarm	Enable, when the alarm happens, it will be play audio to alarm. Choose the audible alarm file (set at the “ <b>Configuration &gt; Alarm &gt; Audible Alarm Output</b> ”).	[How to set] Click to enable Audio Detection Alarm [Default value] <b>OFF</b>
Alarm Record	Enable the button to enable the alarm record.	[How to set] Click to enable Alarm Record. [Default value] <b>OFF</b>
SMTP	Enable the button to enable SMTP sever. The parameters of SMTP can be set at <b>Configuration &gt; Network Service &gt; SMTP</b> interface.	[How to set] Click to enable SMTP. [Default value] <b>OFF</b>

Parameter	Description	Setting
FTP Upload	Enable the button to enable File Transfer Protocol. The parameters of FTP can be set at <b>Configuration &gt; Network Service &gt; FTP</b> interface.	[How to set] Click to enable FTP Upload. [Default value] <b>OFF</b>
Video Stream Draw Line	Enable, the deployment frame will show on the live video.	[How to set] Click to enable Video Stream Draw Line. [Default value] <b>OFF</b>

### Step 3 Set a deployment area

Move the cursor to the drawing interface and click to generate a point, move the cursor to draw a line, and then click to generate another point. This is how a line is generated. In this way, continue to draw lines to form any shape, and right-click to finish line drawing.



#### NOTE

A drawn line cannot cross another one, or the line drawing fails.

Any shape with 8 sides at most can be drawn.

The quantity of deployment areas is up to 8.

### Step 4 Set deployment time.


**Method 1:** Click left mouse button to select any time point within 0:00-24:00 from Monday to Sunday as shown in Figure 5-2.

**Method 2:** Hold down the left mouse button, drag and release mouse to select the deployment time within 0:00-24:00 from Monday to Sunday.



#### NOTE

When you select time by dragging the cursor, the cursor cannot be moved out of the time area. Otherwise, no time can be selected.

**Method 3:** Click  in the deployment time page to select the whole day or whole week.


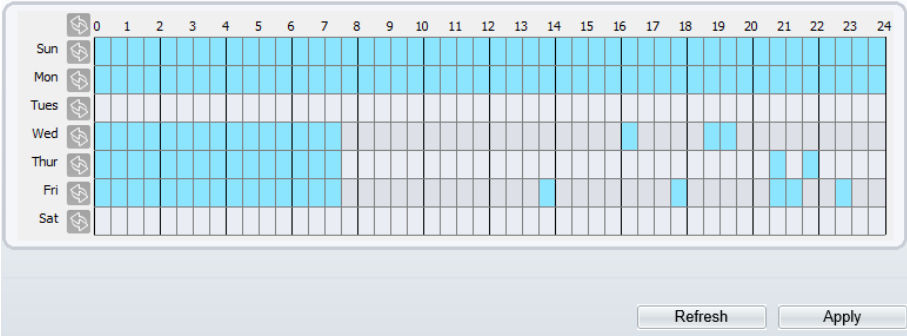
**Deleting deployment time:** Click  again or inverse selection to delete the selected deployment time.

Figure 5-2 Deployment Time Setting Interface



Step 5 Click Apply to save settings.

----End

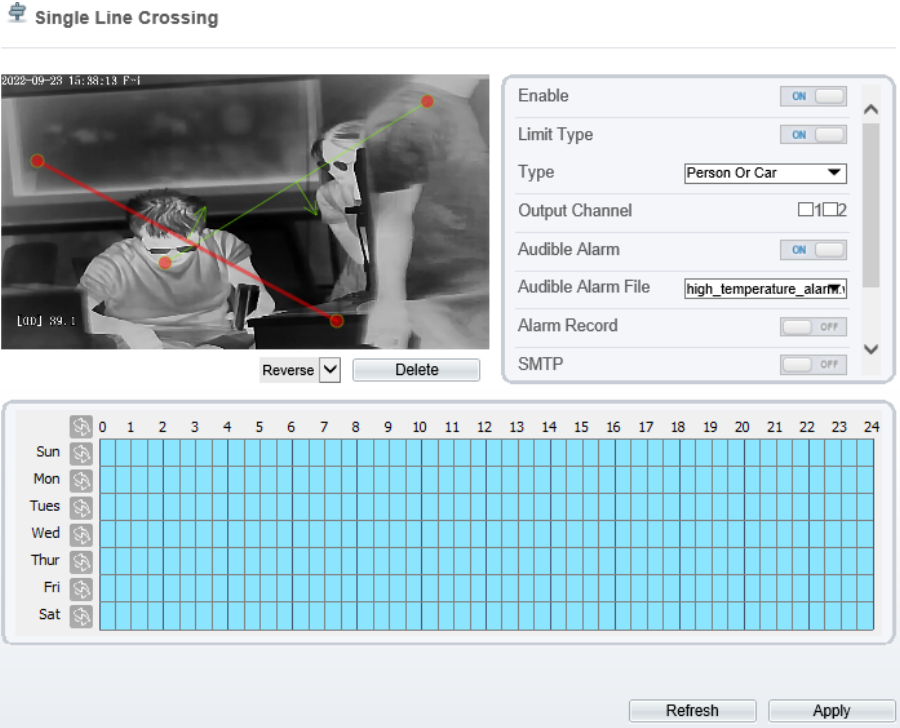
## 5.2 Single Line Crossing

A Single Line Crossing is a line that is set at a concerned position within the monitored field of view and specifies the forbidden travel direction, an alarm is generated when the targets of specified types (such as person or car) cross this line.

### Operation Procedure

Step 1 Select **Intelligent Analysis > Single Line Crossing** to access the **Single Line Crossing** interface, as shown in Figure 5-3.

Figure 5-3 Single Line Crossing Interface



Step 2 Set all parameters for the Single Line Crossing. Table 5-2 describes the specific parameters.

Table 5-2 Parameters of Single Line Crossing

Parameter	Description	Setting
Enable	Enable the button to enable the alarm.	[How to set] Click Enable to enable . [Default value] OFF
Limit Target Type	Effective alarms are set based on target type, with options of Person or Car, person, car. When the device is used indoors, because of small space and large targets, alarms are triggered by person sometimes even if car is selected, leading to false alarms. It is recommended to set the target type as person for indoor use.	[How to set] Click to enable Limit Target Type. [Default value] OFF



Parameter	Description	Setting
Output Channel	If you check to set the Output Channel and the device is connected to an external alarm indicator, the alarm indicator signals when an alarm is triggered.	[How to set] Click to select an ID.
Audible alarm	Enable, when the alarm happens, it will be play audio to alarm. Choose the audible alarm file (set at the “ <b>Configuration &gt; Alarm &gt; Audible Alarm Output</b> ”).	[How to set] Click to enable Audio Detection Alarm [Default value] <b>OFF</b>
Alarm Record	Enable the button to enable the alarm record.	[How to set] Click to enable Alarm Record. [Default value] <b>OFF</b>
SMTP	Enable the button to enable SMTP sever. The parameters of SMTP can be set at <b>Configuration &gt; Network Service &gt; SMTP</b> interface.	[How to set] Click to enable SMTP. [Default value] <b>OFF</b>
FTP Upload	Enable the button to enable File Transfer Protocol. The parameters of FTP can be set at <b>Configuration &gt; Network Service &gt; FTP</b> interface.	[How to set] Click to enable FTP. [Default value] <b>OFF</b>
Video Stream Draw Line	Enable, the deployment frame will show on the live video.	[How to set] Click to enable Video Stream Draw Line. [Default value] <b>OFF</b>

### Step 3 Set a deployment area

**Drawing a line:** move the cursor to the drawing interface, hold down the left mouse button, and move the cursor to draw a line. When you release the left mouse button, a Single Line Crossing is generated.

**Setting a single virtual fence:** click a line (and the trip line turns red) to select the Single Line Crossing and set its direction as **positive**, **reverse** or **bidirectional**, or **delete the selected** line. You can also press and hold left mouse button at the endpoint of a Single Line Crossing and move the mouse to modify the position and length of this single virtual fence. You can right-click to delete the single virtual fence.

 **NOTE**

Try to draw the Single Line Crossing in the middle, because the recognition of a target takes time after target appearance on the screen and an alarm is generated only when the object is recognized to have crossed the single virtual fence.

The Single Line Crossing which detects person foot as the recognition target cannot be too short, because a short Single Line Crossing tends to miss targets.

Step 4 Set deployment time.

For more details please refer to *5.1Step 4*.

Step 5 Click **Apply** to save settings.

**---End**

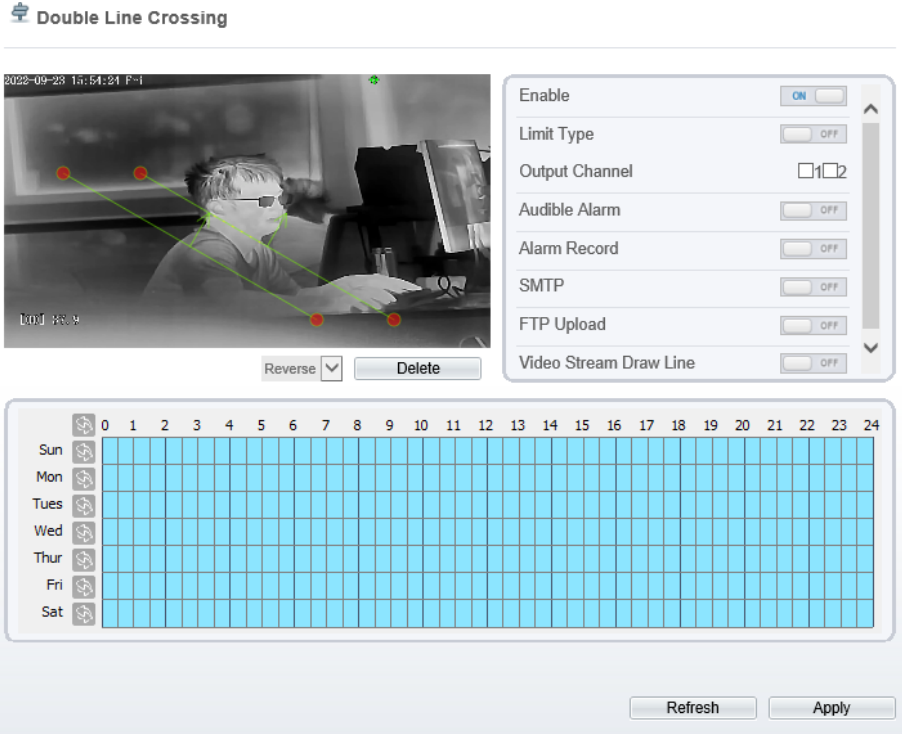
## 5.3 Double Line Crossing

Double Line Crossing refer to two lines that are set at a concerned special position within the field of view and specify the forbidden travel direction. When the targets of specified types (such as person or car) move along the set travel direction and cross these lines in a certain order (line 1 followed by line 2) in pass max time, an alarm is generated.

### Operation Procedure

Step 1 Select **Intelligent Analysis > Double Line Crossing** to access the **Double Line Crossing** interface, as shown in Figure 5-4.

Figure 5-4 Double Line Crossing Interface



Step 2 Set all parameters for the Double Line Crossing. Table 5-3 describes the specific parameters.

Table 5-3 Parameters of Double Line Crossing

Parameter	Description	Setting
Enable	Enable the button to enable the alarm.	[How to set] Click to enable. [Default value] OFF
Limit Target Type	Effective alarms are set based on target type, with options of Person or Car, person, car. When the device is used indoors, because of small space and large targets, alarms are triggered by person sometimes even if car is selected, leading to false alarms. It is recommended to set the target type as person for indoor use.	[How to set] Click to enable Limit Target Type. [Default value] OFF

Parameter	Description	Setting
Output Channel	If you check to set the Output Channel and the device is connected to an external alarm indicator, the alarm indicator signals when an alarm is triggered.	[How to set] Click to select an ID.
Audible alarm	Enable, when the alarm happens, it will be play audio to alarm. Choose the audible alarm file (set at the “ <b>Configuration &gt; Alarm &gt; Audible Alarm Output</b> ”).	[How to set] Click to enable Audio Detection Alarm [Default value] <b>OFF</b>
Alarm Record	Enable the button to enable the alarm record.	[How to set] Click to enable Alarm Record. [Default value] <b>OFF</b>
SMTP	Enable the button to enable SMTP sever. The parameters of SMTP can be set at <b>Configuration &gt; Network Service &gt; SMTP</b> interface.	[How to set] Click to enable SMTP. [Default value] <b>OFF</b>
FTP Upload	Enable the button to enable File Transfer Protocol. The parameters of FTP can be set at <b>Configuration &gt; Network Service &gt; FTP</b> interface.	[How to set] Click to enable FTP. [Default value] <b>OFF</b>
Video Stream Draw Line	Enable, the deployment frame will show on the live video.	[How to set] Click to enable Video Stream Draw Line. [Default value] <b>OFF</b>

### Step 3 Set a deployment area

**Drawing a line:** Move the cursor to the drawing interface, hold down the left mouse button, and move the cursor to draw two lines. When you release the left mouse button, two numbered virtual fences are generated. Choose either of the Double Line Crossing to set the direction to Positive or Reverse.

**Setting double virtual fences:** Click one of the Double Line Crossing (and the virtual fence turns red) to select this virtual fence and set the direction to **Positive** or **Reverse**, or delete the selected line. You can also press and hold left mouse button at the

endpoint of a virtual fence and move the mouse to modify the position and length of this virtual fence. You can right-click to delete the double line crossing.

### **NOTE**

The two virtual fences are in sequential order. An alarm is generated only when a target crosses virtual fence 1 and then virtual fence 2 within the set maximum passing time.

Try to draw Double Line Crossing in the middle, because the recognition of a target takes time after target appearance on the screen and an alarm is generated only when the object is recognized to have crossed the double virtual fences.

The Double Line Crossing which detect person foot as the recognition target cannot be too short, because short Double Line Crossing tend to miss targets.

Step 4 Set deployment time.

For more details please refer to *5.1Step 4*.

Step 5 Click **Apply** to save settings.

----End

## 5.4 Object Left

### Description

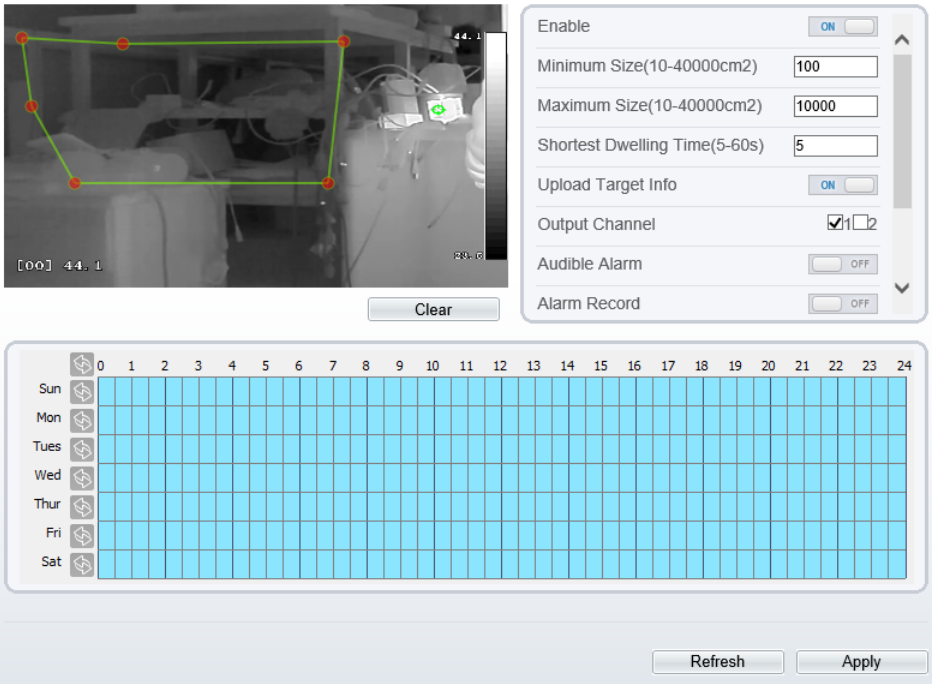
The object left function refers to that an alarm is generated when the dwelling time of an object within the deployment area meets the set shortest dwelling time.

### Procedure

Step 1 Select **Configuration > Intelligent Analysis > Object Left** to access the **Object Left** setting interface, as shown in Figure 5-5.

Figure 5-5 Object Left Setting Interface




 Object Left



Step 2 Set all parameters for Object Left, The details please refer to Table 5-4.

Table 5-4 Parameters of Object Left

Parameter	Description	Setting
Enable	Enable the button to enable the alarm.	[How to set] Click Enable to enable. [Default value] OFF
Minimum (Maximum) Size(10-40000cm <sup>2</sup> )	The target size for triggering an effective alarm is set based on the actual target size. The minimum size is 100 square centimeters and the maximum 10000 square centimeters. When setting the target size, you need to well set “Real size in scene” in advanced parameters, otherwise no alarms may be generated.	[How to set] Input a value in the area box.

Shortest Dwelling Time (Sec)	An alarm is generated when the object left time is longer than the shortest dwelling time. Setting range: 5-60 seconds.	[How to set] Input a value in the area box. [Default value] 5s
Upload Target Info	Enable the function of uploading target information by clicking  below the real-time video in a browser to turn  into  . When an alarm is triggered, the target movement trace can be displayed (The trace can be seen only within the deployment area and disappears after the target leaving the deployment area).	[How to set] Click to enable Upload Target Info. [Default value] OFF
Output Channel	If you check to set the Output Channel and the device is connected to an external alarm indicator, the alarm indicator signals when an alarm is triggered.	[How to set] Click to select an ID.
Audible Alarm	Enable, when the alarm happens, it will be play audio to alarm. Choose the audible alarm file (set at the “ <b>Configuration &gt; Alarm &gt; Audible Alarm Output</b> ”).	[How to set] Click Enable to enable. [Default value] OFF
Alarm Record	Enable the button to enable the alarm record.	[How to set] Click to enable Alarm Record. [Default value] OFF
SMTP	Enable the button to enable SMTP sever. Details please refer to <i>chapter 10.5</i> .	[How to set] Click to enable SMTP. [Default value] OFF
FTP Upload	Enable the button to enable File Transfer Protocol. Details please refer to <i>chapter 10.6</i> .	[How to set] Click to enable FTP Upload. [Default value] OFF

Video Stream Draw Line	Enable, the deployment frame will show on the live video.	[How to set] Click to enable Video Stream Draw Line. [Default value] <b>OFF</b>
------------------------	---	--

Step 3 Set a deployment area.

Move the cursor to the drawing interface and click to generate a point, move the cursor to draw a line, and then click to generate another point. This is how a line is generated. In this way, continue to draw lines to form any shape, and right-click to finish line drawing.



#### NOTE

- A drawn line cannot cross another one, or the line drawing fails.
- Any shape with 32 sides at most can be drawn.
- The quantity of deployment areas is up to 8.

Step 4 Set deployment time. For more details please refer to *5.1Step 4*.

Step 5 Click **Apply** to save settings.

---End

## 5.5 Object Removed

### Description

The object removed function refers to that an alarm is generated when the removing time of an object within the deployment area meets the set shortest removing time.

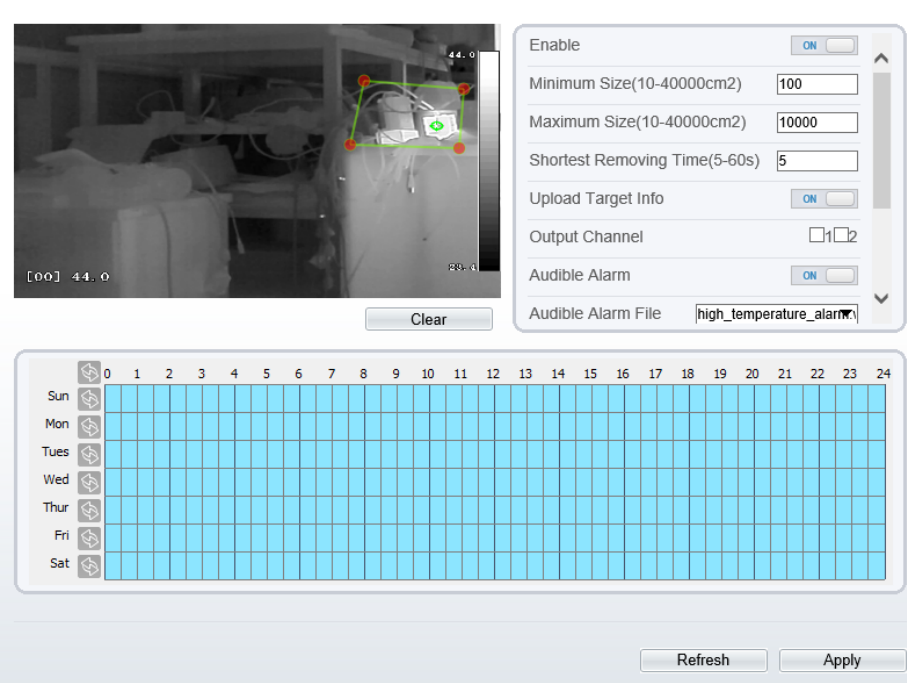
### Procedure

Step 1 Select **Configuration > Intelligent Analysis > Object Removed** to access the **Object Removed** setting interface, as shown in Figure 5-6.



Figure 5-6 Object Removed Setting Interface

 Object Removed



Step 2 Set all parameters for object removed, The details please refer to Table 5-2.

Step 3 Set a deployment area.

Move the cursor to the drawing interface and click to generate a point, move the cursor to draw a line, and then click to generate another point. This is how a line is generated. In this way, continue to draw lines to form any shape, and right-click to finish line drawing.

 **NOTE**

- A drawn line cannot cross another one, or the line drawing fails.
- Any shape with 32 sides at most can be drawn.
- The quantity of deployment areas is up to 8.

Step 4 Set deployment time. For more details please refer to 5.1Step 4.

Step 5 Click **Apply** to save settings.

----End

## 5.6 Advanced

### Description

Set the scene and the actual size of the scene, according to depth of field validate, so that it provides scene reference data for the camera.


Figure 5-7 Advanced

#### Advanced

Scene	Outdoor
ID	
Real Size In Scene(10-10000cm)	0
Alarm Interval(1-1800S)	10

2000-01-01 04:15:46 Sat



Depth of field validate

Delete

Refresh

Apply

Table 5-5 Parameter of advanced

Parameter	Description	Setting
Scene	The scene which camera installed. Select indoor/outdoor base on the Environment.	[How to set] Select from the drop-down list box. [Default value] Indoor
ID	Mark the line base on the ID of line, select the according line by the ID.	Automatic generated
Real Size in Scene (10-10000 cm)	Length of line according to the real size in scene. The default value is 0 and the setting value is 10-10000 centimeters.	[Setting method] Input a number from 10 to 10000
Alarm Interval (1-1800 S)	The interval of intelligent analysis alarm.	[Setting method] Input a number from 1 to 1800 [Default value] 10
Depth of Field Validate	Validate the size of setting area in the scene according the marking line.	[How to set] Click to enable Upload Target Info. [Default value] OFF

## Procedure

In the advanced parameter setting, the mapping relationship between the actual target and the image target is calibrated by drawing a line.

The line drawing method and rules are as follows:

- It is required to input 2-4 vertical line segments or 2 vertical line segments and 2 horizontal line segments.
- When the calibration requirements are not high, drawing 2 vertical line segments can meet the requirements of most scenes. Vertical line segments are generally calibrated according to human height.
- The line segments need to be distributed in near and far directions. The vertical line segment draws one each at the distance of the scene, draws a vertical line along the height of the target object, measures the actual length of the corresponding target, and input the actual length in the "real size in scene " and saves. In the same way, draw one horizontal line at each distance, measure and input the actual length.
- Choose the line ID, or Click the calibration line segment (the line segment turns red), and click "Delete" to delete the calibration line segment.

- Click to calibrate the line segment (the line segment turns to red) to modify the length of the line segment, or select the ID through the advanced parameter interface to modify the "real size in scene" of the corresponding line segment.

**----End**

## 6 A Troubleshooting

Common Trouble	Possible Cause	Solution
Unable to access the web	Network is not connected.	Connect the network cable of the camera to the PC to check whether the network cable is in good contact. Run the ping command to check the network connection and whether the device works normally.
	IP address is occupied.	Directly connect the camera to the PC, and reset the IP address of the camera.
	The IP addresses of the PC and the device are in different networks.	Check the IP address, subnet mask and gateway setting of the camera.
The measured temperature is not accurate.	The device is just powered on, and the temperature of the cavity is unstable.	The temperature of the cavity is stable within 15 to 30 minutes after the device is powered on.
	The FFC mode is incorrect.	The FFC default mode is automatic. If the mode is set to manual, it will be no block calibration, which may lead to fuzzy pictures and inaccurate temperature.
	The target configuration is incorrect.	Check whether the emission rate and distance of the target are configured correctly.

Common Trouble	Possible Cause	Solution
An error occurs in accessing the web of the device after the upgrade.	The data in the cache of browser is not updated in time.	<p>Delete the cache of browser. The steps are as follows (taking Edge as an example):</p> <p>Open the Edge browser.</p> <p>Press Ctrl + Shift + Delete, the <b>Delete Browsing History</b> dialog box appears.</p> <p>Select all check boxes.</p> <p>Click <b>Delete</b>.</p> <p>Relogin the web page of the camera.</p>
Upgrade failed.	No network cable is connected. The network setting is incorrect.	Ensure the upgrade network is connected. Check whether the network setting is correct.
	The upgrade package is incorrect.	Perform the correct upgrade package again.

## B Common Emission Rate

### Emission Rate

The emission rate is the capability of an object to emit or absorb energy. An ideal transmitter provides an emission rate of emitting 100% of intake energy. An object with an emission rate of 0.8 can absorb 80% of intake energy, and reflect the remaining 20%. The emission rate is the ratio of the energy emitted by an object at a specific temperature to that emitted by an ideal radiator at the same temperature. The range of emission rate value is 0.0 to 1.0 generally.

Materials	Temperature (°C/°F)	Emissivity
Gold (High-purity)	227/440	0.02
Aluminum foil	27/81	0.04
Aluminum sheet	27/81	0.18
Aluminum used for families (flat)	23/73	0.01
Aluminum plate (98.3% purity)	227/440	0.04
	577/1070	0.06
Aluminum plate (rough)	26/78	0.06
Aluminum (oxidized @ 599°C)	199/390	0.11
	599/1110	0.19
Polished aluminum	38/100	0.22
Tin (light tinned Iron sheet)	25/77	0.04

Nickel wire	187/368	0.1
Lead (99.9% purity, No oxidized)	127/260	0.06
Copper	199/90	0.18
Cobalt	599/1110	0.19
Steel	199/390	0.52
	599/1110	0.57
Tinned iron sheet (Light)	28/82	0.23
Brass (High-polish)	247/476	0.03
Brass (Tough rolled, polished metal wire)	21/70	0.04
Tinned Iron (Light)	-	0.13
Iron plate (Rust eaten)	20/68	0.69
Rolled steel sheet	21/71	0.66
Ferric oxide	100/212	0.74
Wrought-iron	21/70	0.94
Fused iron	1299-1399/3270-2550	0.29
Copper (Polished)	21-117/70-242	0.02
Copper (Polished, not reflected)	22/72	0.07
Copper (Heavy oxide Board)	25/77	0.78
Enamel (Fuse on iron)	19/66	0.9
Formica Plate	27/81	0.94



Frozen soil	-	0.93
Brick (Red, rough)	21/70	0.93
Brick (Unglazed, rough)	1000/1832	0.8
Carbon (T - carbon 0.9% ash)	127/260	0.81
Concrete	-	0.94
Glass (Glossy)	22/72	0.94
Granite (Surfaced)	21/70	0.85
Ice	0/32	0.97
Marble (I Polished, grey)	22/72	0.93
Asbestos board	23/74	0.96
Asbestos paper	38/100	0.93
	371/700	0.95
Asphalt (Paving the road)	4/39	0.97
Paper (Black tar)	-	0.93
Paper (White)	-	0.95
Plastic (White)	-	0.91

101-300-0496-03