

Network Video Recorder(NVR) Quick Setup Guide

NO.:101-600-0219-03
Issue:1.3

Precautions

Fully understand this document before using this device, and strictly observe rules in this document when using this device. If you install this device in public places, provide the tip "You have entered the area of electronic surveillance" in an eye-catching place. Failure to correctly use electrical products may cause fire and severe injuries.

WARNING	It alerts you to moderate dangers which, if not avoided, may cause minor or moderate injuries.
CAUTION	It alerts you about risks. Neglect of these risks may cause device damage, data loss, device performance deterioration, or unpredictable results.
NOTE	It provides additional information.

WARNING
• Strictly observe installation requirements when installing the device. The manufacturer shall not be held responsible for device damage caused by users' non-conformance to these requirements.

• Strictly conform to local electrical safety standards and use power adapters that are marked with the LPS standard when installing and using this device. Otherwise, this device may be damaged.

• Use accessories delivered with this device. The voltage must meet input voltage requirements for this device.
• If this device is installed in places with unsteady voltage, ground this device to discharge high energy such as electrical surges in order to prevent the power supply from burning out.

• When this device is in use, ensure that no water or any liquid flows into the device. If water or liquid unexpectedly flows into the device, immediately power off the device and disconnect all cables (such as power cables and network cables) from this device.

• If this device is installed in places where thunder and lightning frequently occur, ground the device nearby to discharge high energy such as thunder strikes in order to prevent device damage.

CAUTION

• Avoid heavy loads, intensive shakes, and soaking to prevent damages during transportation and storage. The warranty does not cover any device damage that is caused during secondary packaging and transportation after the original packaging is taken apart.

• Protect this device from fall-down and intensive strikes, keep the device away from magnetic field interference, and do not install the device in places with shaking surfaces or under shocks.

• Clean the device with a soft dry cloth. For stubborn dirt, dip the cloth into slight neutral cleanser, gently wipe the dirt with the cloth, and then dry the device.

• Do not jam the ventilation opening. Follow the installation instructions provided in this document when installing the device.

• Keep the device away from heat sources such as radiators, electric heaters, or other heat equipment.

• Keep the device away from moist, dusty, extremely hot or cold places.

• If the device is installed outdoors, take insect- and moisture-proof measures to avoid circuit board corrosion that can affect monitoring.

• Remove the power plug if the device is idle for a long time.

Special Announcement

• All complete products sold by the manufacturer are delivered along with nameplates, quick setup guide and accessories after strict inspection. The manufacturer shall not be held responsible for counterfeit products.

• The manufacturer will update this manual according to product function enhancement or changes and regularly update the software and hardware described in this manual. Update information will be added to new versions of this manual without prior notice.

• This manual may contain misprints, technology information that is not accurate enough, or product function and operation description that is slightly inconsistent with the actual product, the final interpretation of company is as a standard.

• This manual is only for reference and does not ensure that the information is totally consistent with the actual product. For consistency, see the actual product.

NOTE
For more information, please refer to website.

1 Open Package Examination

Open the package, check the appearance of product for no obvious damage, and confirm the item list for table 1-1 is consistent.

Table 1-1 Packing list

Component	Quantity	Remark
Network video recording	1	
Quick Setup Guide	1	
Mouse	1	
Power adapter	1	
Power cord	1	
Phillips head screw	6	

2 Device Structure

2.1 Device Ports

NOTE

Different device may have different ports and multi-head cable; Please refer to the actual product.

Front panel description of device refer to table 2-1.

Table 2-1 Front panel description

Port Name	Description
PWR Indicator	When the NVR is operating, the PWR indicator is steady on. When the NVR is shut down, the PWR indicator is turned off.
HDD Indicator	Hard disk status indicator This indicator flashes when data is transmitted.
PoE Indicator	PoE network status indicator This indicator flashes when data is transmitted.
KB/MOUSE	Support connection to an USB mouse
BACKUP	Support connection to a USB flash drive or USB removable hard disk.

Rear panel description of device, please refer to table 2-2.

Table 2-2 Rear panel description

Name	Description
POE Port	POE network interfaces
LAN	RJ45 10 /100/1000 Mbps adaptive Ethernet interface
AUDIO OUT/ AUDIO IN	Audio output / Audio input
VGA	Video output interface
HDMI	
Alarm I/O	Alarm input/Alarm output
DC12V/DC48V	Connected to an external power adapter

2.2 Device Dimensions

NOTE

Different device may have different dimensions, please refer to the actual product.

Figure 2-1 Dimensions (Unit:mm)

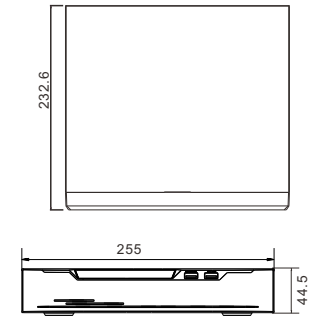

3 Device Installation

The hard disk of the NVR must be provided by the user. Take the following steps to install hard disk:

Step 1 Remove the screws for fixing the cover and take down the cover.

Step 2 Take out the screws and mount two of them to the screw holes, as shown in figure 3-1.

Figure 3-1 Installing the hard disk screws

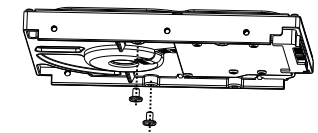

NOTE

Just screw the screws about 1 to 2 turns, instead of tightening.

Step 3 Route the screws through the cucurbit holes on the base, push the hard disk to the appropriate position, as shown in figure 3-2.

Figure3-2 Installing hard disk

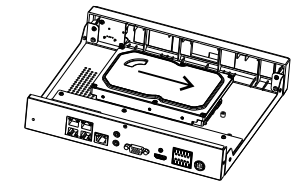

Step 4 Turn the device over, and mount another two screws to the holes as shown in figure 3-3. Then fasten all screws.

Figure3-3 Fixing hard disk

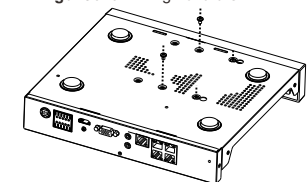

Step 5 Insert the hard disk data cable and power cable, then replace the upper cover and fasten the fixing screws.

4 Device Operation

4.1 Startup

Before starting NVR, ensure that the NVR is connected to a power supply properly and a monitor is connected to the HDMI or VGA interface of the NVR correctly. After starting the NVR, there is a login window located in the center, as shown in figure 4-1.

CAUTION In some environments, if the power supply is abnormal, the NVR may not work properly. In severe cases, the NVR may be damaged. In these environments, you are advised to use regulated power supply.

Figure 4-1 Activation interface

Figure 4-2 Login interface

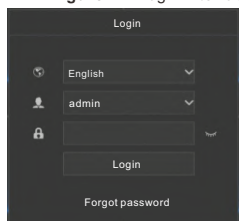
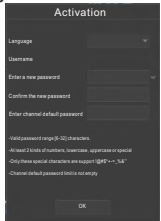

NOTE

The default user name and password both are **admin**. For system security, users will be forced to modify password when login the system at the first time.

If the NVR need activation, please create a new password to login. User can change the system display language on the login window.

4.2 Topology of the NVR

NVR with PoE ports can access IP cameras immediately when plug IP cameras into NVR's PoE ports. Then the NVR will assign an IP address for each camera automatically. The topology refer to figure 4-3.

Figure 4-3 Topology of the NVR

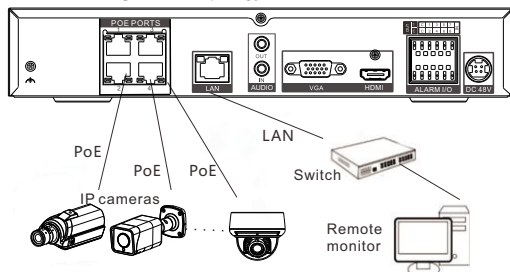

4.3 Special Function

Click the AI Recognition icon, human face, or Thermal Temperature at the bottom of page to enter the AI interface, use can set and view the AI cameras' parameters, include human face, vehicle license plate.

4.4 Power off

Enter the path **Main Menu > System > Maintenance > Shutdown** to power off the NVR.

NOTE

Before replacing the hard disk, the power must be turned off. The special function is only carried by some devices, if the current device doesn't have the function, please ignore it.

5 Quick Configuration

Plug in power to access the NVR user page, the wizard window would show at first time; User can configure quickly or close immediately. The configuration details please refer to main menu. Use mouse to right-click any where of the main interface to access the main menu. Main menu comprises Channel, Record, Alarm, Network and System settings, as shown in figure 5-1.

5.1 Channel

Channel settings contain Camera, Encode, Image, OSD, Privacy Zone.

- Camera:** user can add cameras automatically by clicking **Click to Add**, and add manually by clicking **add**. Tick cameras then click **Delete** to delete cameras. User can batch update software.

Figure 5-1 Main menu

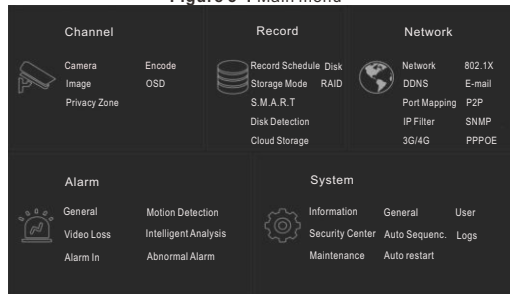

- Image:** adjust image parameters and user can set sensor parameter.
- OSD:** customize time and channel name displaying in the live video page.
- Privacy Zone:** set a privacy zone by clicking and dragging cursor and double-click an exist private area to delete it. Support up to 4 zones.
- All these settings can be copied to other channels by clicking **copy** button.

5.2 Record

Record settings contain Record Schedule, Disk, Storage, RAID, SMART, Disk Detection and Cloud Storage.

Set record schedule and storage strategic. Enter SMART interface to view the state of disks. Disk detection can detect the disks.

Cloud storage can storage alarm recording.

5.3 Alarm

Alarm settings contain General, Motion detection, Video loss, Intelligent analysis, Alarm in, Abnormal alarm as shown in figure 5-2.

Figure 5-2 Alarm

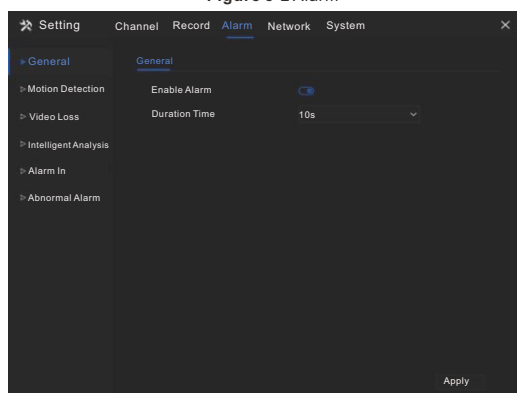

General: enable or disable alarm and set duration time of alarm.

- Motion Detection:** enable this function, if detection the motion actions, it will alarm.

- Event actions:** contain buzzer, alarm out, push message to App, pop-up message to monitor, send E-mail and post recording (after enabling, choose the recording time from drop list.)

- Area:** set motion detection area. Press left button and drag the cursor to add a detection area, and double-click an area to delete it.

- Schedule:** set schedule to enable or disable motion detection alarm. There are three methods to set, click the double arrows button to choose all day. The second, click and drag the cursor to select periods. The third, click one by one.

- Video Loss, Intelligent Analysis** are same settings as motion detection.

- Alarm In:** settings for I/O alarming. **Abnormal Alarm** can tick disk error, IP conflict, network disconnected.

5.4 Network

Network settings contain Network, 802.1X, DDNS, E-mail, Port Mapping, P2P, IP Filter, SNMP, 3G/4G, and PPPoE as shown in figure 5-3. Maybe some models have more functions; Please refer to the actual product.

Figure 5-3 Network

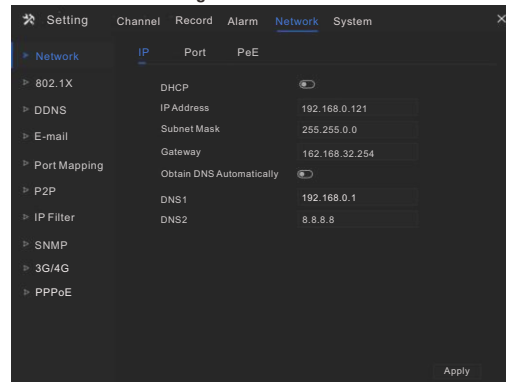

- Network, 802.1X, DDNS, and SNMP** interface to set network parameters.
- E-mail:** set E-mails for sending and receiving alarm messages and password retrieval message.
- Port Mapping:** set the ports for remote accessing.
- P2P:** add NVR into device list of App by accessing the QR code.
- IP Filter:** settings for creating black list or white list.
- 3G/4G:** use 3G/4G modem plug to NVR provide the network.
- PPPoE:** point to point network to access NVR directly.

5.5 System

System settings contain Information, General, User, Password, Auto Sequence, Logs, Maintenance and Auto Restart, as shown in Figure 5-4.

Figure 5-4 System

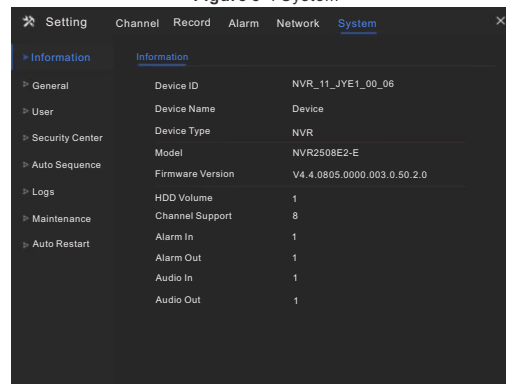

- General:** include system, date and time, time zone, DST.
- User:** add user and set advance setting (auto login, password double authentication, boot wizard).
- Security Center:** modify the password, pattern unlock, secure Email, Secure question.
- Auto Sequence:** settings for sequencing view of the channels.
- Logs:** shows operating and alarm log, user can export logs if an USB disk is plugged in.
- Maintenance:** include shutdown, reboot, exit system, reset, import configuration, export configuration and update.
- Auto Restart:** enable this function to make device restart periodically.

5.6 Live Video

Live video page is showed after starting the NVR by default, as shown in figure 5-5.

Figure 5-5 Live video



6 Mobile Client

Search for "InView Pro4" in App Store or Google Play to download and install the mobile client. Use the App to scan the QR code on the back board of NVR, or in P2P settings page in NVR user interface. Then input the password of the NVR to add the NVR into the device list of the App. User can manage the device through mobile client.

Figure 6-1 P2P

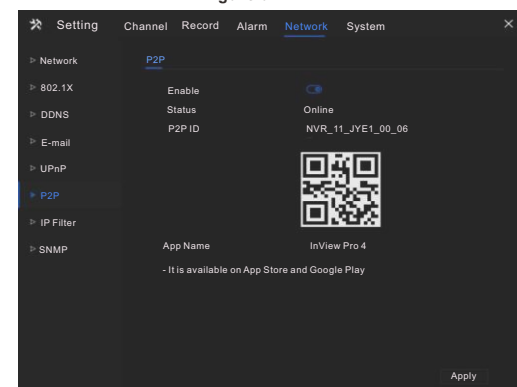

7 Web Accessing

The NVR also can be accessed in a Web browser. Open a web browser like IE and enter the IP address of device (The default IP address is 192.168.0.121) in the address box, and press **Enter**. The login page is displayed as shown in figure 7-1.

Figure 7-1 Login

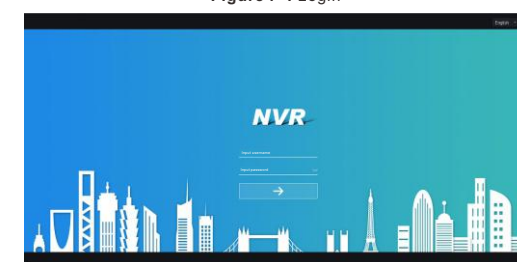

NOTE

The user name and password are same as the UI interface.